

FORGEFIELD



info@forgefieldinternational.com

www.forgefieldinternational.com

Surgical Instruments





General Instruments

Artery Forceps

Clamps

Spring Forceps

Tissue Forceps

Sponge Holding and Sterilising Forceps

Other Forceps

Scissors

Needle Holders

Combined Scissor and Needle Holders

Bag and Towel Clips

Retractors

Dissectors and Probes

Miscellaneous

Hollow Ware

Silicone Matting





Artery Forceps

Adson Artery Forceps

Box joint, 180mm long

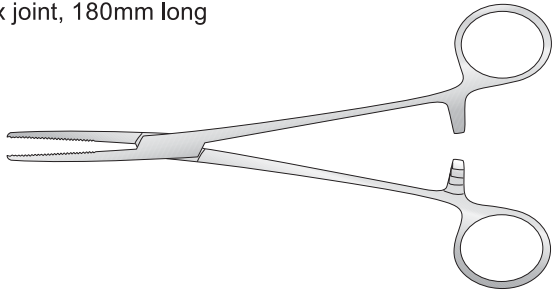

Serrated jaws

Code	Description
SC-GI/034	Straight
SC-GI/034a	Curved

1-2 teeth

Code	Description
SC-GI/034b	Straight
SC-GI/034c	Curved

Cushing Artery Forceps

Box joint, fine, half serrated jaws, 140mm long

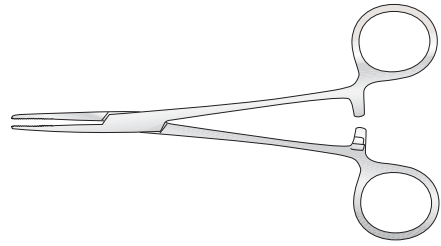

Code	Description
SC-GI/001	Straight
SC-GI/002	Curved

Cairns Artery Forceps

Box joint, half serrated jaws
145mm long

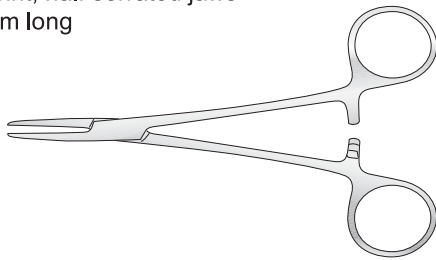

Serrated jaws

Code	Description
SC-GI/415	Straight

1-2 teeth

Code	Description
SC-GI/020	Curved
SC-GI/021	Curved to side

Dunhill Artery Forceps

Box joint, fine serrations

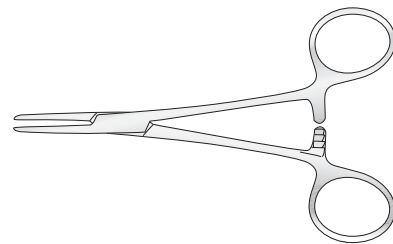

Straight

Code	Description
SC-GI/065	135mm long
SC-GI/065a	190mm long

Curved

Code	Description
SC-GI/043	135mm long
SC-GI/468	180mm long

Crile Artery Forceps

Box joint, serrated jaws

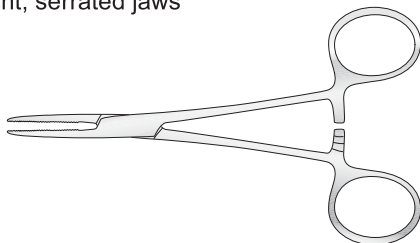

Straight

Code	Description
SC-GI/014	140mm long
SC-GI/014a	160mm long

Curved

Code	Description
SC-GI/015	140mm long
SC-GI/015a	160mm long

Lawson Tait Artery Forcep

Box joint, straight jaw

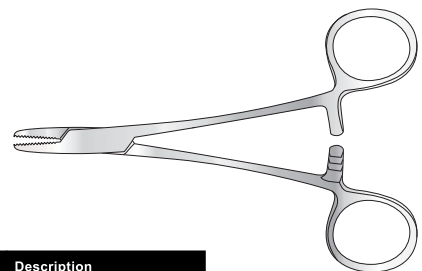

Code	Description
SC-GI/SH5924	140mm long



Halstead Mosquito Forceps

Standard pattern, haemostatic, box joint

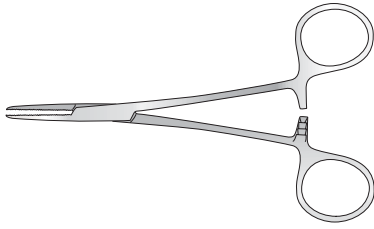

Serrated jaw

Code	Description
SC-GI/007	Straight 125mm long
SC-GI/008	Curved 125mm long
SC-GI/009	Fully curved 125mm long

1-2 teeth

Code	Description
SC-GI/010	Straight 125mm long
SC-GI/012	Straight 190mm long
SC-GI/011	Curved 125mm long
SC-GI/013	Curved 190mm long

Micro, 100mm long

Code	Description
SC-GI/003	Straight, serrated
SC-GI/004	Curved, serrated
SC-GI/005	Straight, 1-2 teeth
SC-GI/006	Curved, 1-2 teeth

Kelly Artery Forceps

Box joint, half serrated jaws



Straight

Code	Description
SC-GI/022	140mm long
SC-GI/023	160mm long

Curved

Code	Description
SC-GI/024	140mm long
SC-GI/025	160mm long

Fraser Kelly Artery Forceps Curved

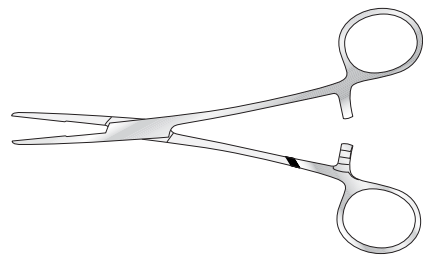

Straight

Code	Description
SC-GI/468a	180mm

Heiss Artery Forceps

Box joint, 205mm long

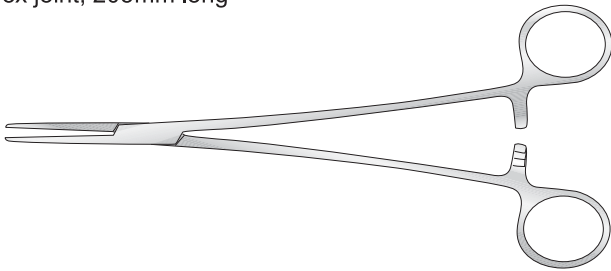

Serrated jaws

Code	Description
SC-GI/016	Straight
SC-GI/017	Curved

1-2 teeth

Code	Description
SC-GI/016a	Straight
SC-GI/017b	Curved

Kocher Artery Forceps

Box joint, 1-2 teeth

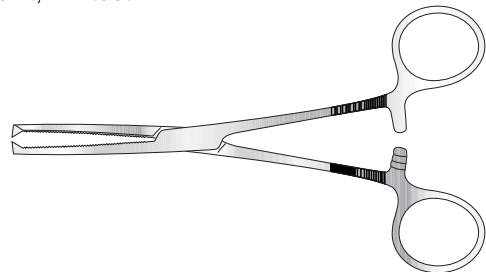

Straight

Code	Description
SC-GI/052	130mm long
SC-GI/053	150mm long
SC-GI/054	180mm long
SC-GI/055	200mm long
SC-GI/056	230mm long

Curved

Code	Description
SC-GI/057	150mm long
SC-GI/058	180mm long
SC-GI/059	200mm long
SC-GI/060	230mm long



Artery Forceps

Moynihan Artery Forceps

Box joint, half-serrated jaws

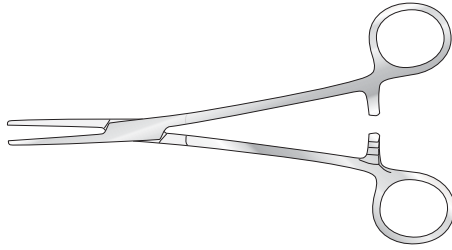

Straight

Code	Description
SC-GI/018	145mm long
SC-GI/068	180mm long

Curved

Code	Description
SC-GI/019	145mm long
SC-GI/069	180mm long

Rochester-Pean Artery Forceps

Box joint

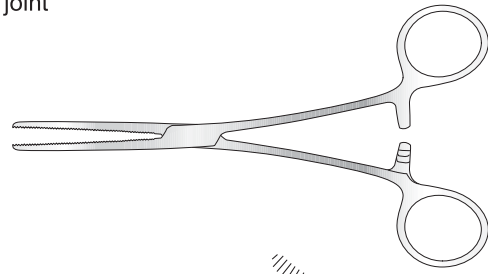

Straight

Code	Description
SC-GI/044	165mm long
SC-GI/045	190mm long
SC-GI/046	205mm long
SC-GI/047	240mm long

Curved

Code	Description
SC-GI/048	165mm long
SC-GI/049	180mm long
SC-GI/050	205mm long
SC-GI/051	240mm long

Roberts Artery Forceps

Screw joint, curved on flat, serrated

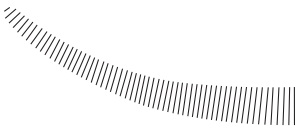
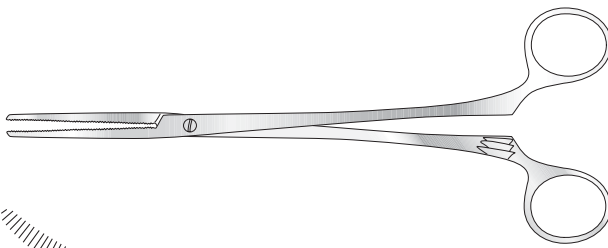

Code	Description
SC-GI/070	230mm long

Spencer Wells Artery Forceps

Box joint, serrated jaws

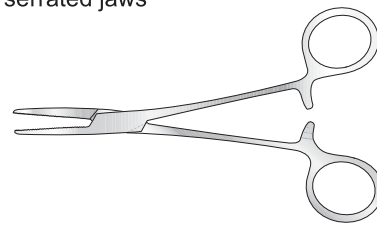

Straight

Code	Description
SC-GI/035	127mm long
SC-GI/036	152mm long
SC-GI/037	177mm long
SC-GI/038	203mm long

Curved

Code	Description
SC-GI/039	127mm long
SC-GI/040	152mm long
SC-GI/041	177mm long
SC-GI/042	203mm long

OTHER SIZES AVAILABLE

Dandy Artery Forceps

Box joint, curved in plane

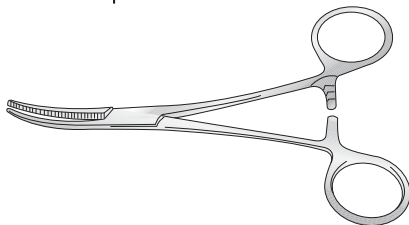

Code	Description
SC-GI/076	140mm long



Carmalt Angiotribe Forceps

Box joint, atraumatic, light pattern

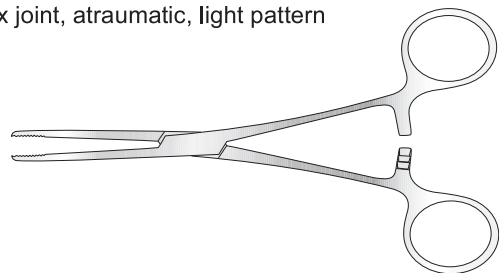

Straight

Code	Description
SC-GI/062	165mm long
SC-GI/063	200mm long
SC-GI/064	230mm long

Curved

Code	Description
SC-GI/061	165mm long



Dieffenbach Bulldog Clamp

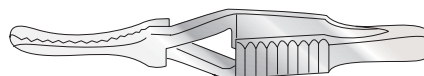

Straight, serrated

Code	Description
SC-GI/112	1.2mm fine jaw, 40mm long
SC-GI/113	1.2mm fine jaw, 45mm long
SC-GI/108	1.8mm jaw, 30mm long
SC-GI/109	1.8mm jaw, 35mm long
SC-GI/110	2.5mm jaw, 40mm long
SC-GI/111	2.5mm jaw, 45mm long
SC-GI/107	6mm heavy jaw, 60mm long
SC-GI/455	20mm jaw, 75mm long
SC-GI/455a	30mm jaw, 85mm long
SC-GI/455b	45mm jaw, 105mm long
SC-GI/455c	65mm jaw, 120mm long

Straight, plain

Code	Description
SC-GI/129	1.2mm fine jaw, 40mm long
SC-GI/131	1.2mm fine jaw, 45mm long
SC-GI/121	1.8mm jaw, 30mm long
SC-GI/123	1.8mm jaw, 35mm long
SC-GI/125	2.5mm jaw, 40mm long
SC-GI/127	2.5mm jaw, 45mm long

Curved, serrated

Code	Description
SC-GI/119	1.2mm fine jaw, 40mm long
SC-GI/120	1.2mm fine jaw, 45mm long
SC-GI/115	1.8mm jaw, 30mm long
SC-GI/116	1.8mm jaw, 35mm long
SC-GI/117	2.5mm jaw, 40mm long
SC-GI/118	2.5mm jaw, 45mm long
SC-GI/114	6mm heavy jaw, 60mm long
SC-GI/456	20mm jaw, 75mm long
SC-GI/456a	30mm jaw, 85mm long
SC-GI/456b	45mm jaw, 105mm long
SC-GI/456c	65mm jaw, 120mm long

Curved, plain

Code	Description
SC-GI/130	1.2mm fine jaw, 40mm long
SC-GI/132	1.2mm fine jaw, 45mm long
SC-GI/122	1.8mm jaw, 30mm long
SC-GI/124	1.8mm jaw, 35mm long
SC-GI/126	2.5mm jaw, 40mm long
SC-GI/128	2.5mm jaw, 45mm long

Forceps Jaw Types

You will notice that the forceps in our catalog come with either a standard serrated jaw or a unique design referred to as atraumatic(or non-traumatic).

Conventional Serrated Jaw



The conventional serrated jaw is typically sturdier and is used on forceps designed for less delicate areas.

Atraumatic Jaw



Atraumatic jaws are primarily used in delicate surgical areas like vascular and cardiothoracic procedures. Their design minimizes the surface area in contact, reducing tissue damage while maintaining a firm grip.

Blalock Bulldog Clamp

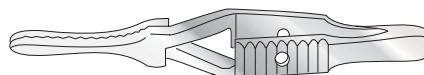

Serrated, with hole in handle

Straight

Code	Description
SC-GI/480	11mm jaw, 38mm long
SC-GI/482	14mm jaw, 48mm long
SC-GI/493	17mm jaw, 60mm long
SC-GI/481	27mm jaw, 70mm long

Curved

Code	Description
SC-GI/478	11mm jaw, 38mm long
SC-GI/479	14mm jaw, 48mm long
SC-GI/491	17mm jaw, 60mm long
SC-GI/492	27mm jaw, 70mm long

Plain, with hole in handle

Straight

Code	Description
SC-GI/486	11mm jaw, 38mm long
SC-GI/487	14mm jaw, 48mm long
SC-GI/488	17mm jaw, 60mm long
SC-GI/489	27mm jaw, 70mm long

Curved

Code	Description
SC-GI/483	11mm jaw, 38mm long
SC-GI/484	14mm jaw, 48mm long
SC-GI/485	17mm jaw, 60mm long
SC-GI/490	27mm jaw, 70mm long



Spring Forceps

Adsons Dissecting Forceps

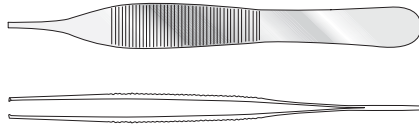

127mm long

Code	Description
SC-GI/257	1-2 teeth
SC-GI/258	Lightweight, micro
SC-GI/259	Serrated
SC-GI/260	Serrated, lightweight, micro

Block End Dissecting Forceps

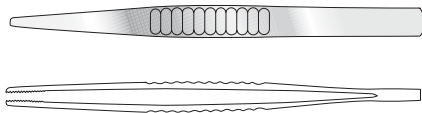

Serrated

Code	Description
SC-GI/255	127mm long
SC-GI/256	152mm long
SC-GI/256a	203mm long

Bonney Dissecting Forceps

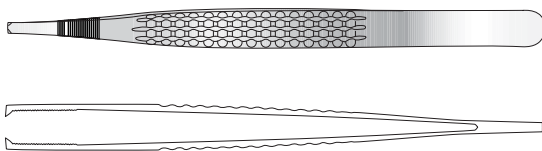

178mm long

Code	Description
SC-GI/267	Serrated, 1-2 teeth
SC-GI/268	1-2 teeth

Charnley-McIndoe Dissecting Forceps

150mm long

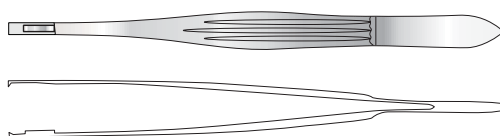

Code	Description
SC-OR/N045a	2-3 teeth

DeBakey Atraumatic Dissecting Forceps

Straight, atraumatic jaws

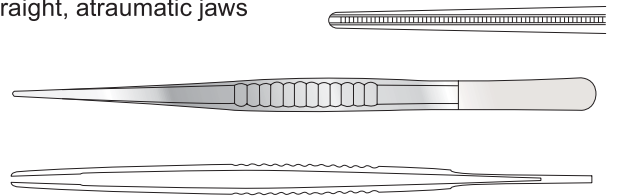

1.5mm

Code	Description
SC-GI/238a	150mm long
SC-GI/240a	240mm long

2.5mm

Code	Description
SC-GI/238b	150mm long
SC-GI/240b	240mm long

2mm

Code	Description
SC-GI/238	150mm long
SC-GI/241	180mm long

2.8mm

Code	Description
SC-GI/238c	150mm long
SC-GI/240c	240mm long
SC-GI/241c	180mm long

Dissecting Forceps

Turnover end, serrated jaws

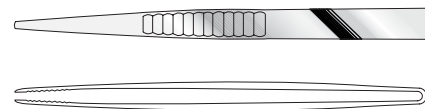

Code	Description
SC-GI/242	127mm long
SC-GI/243	152mm long

Code	Description
SC-GI/244	178mm long
SC-GI/245	203mm long

Dunhill Dissecting Forceps

Light, fine serrated jaws



Code	Description
SC-GI/457	145mm long

Fredrick Coole Dissecting Forceps

Extra fine serrated jaws

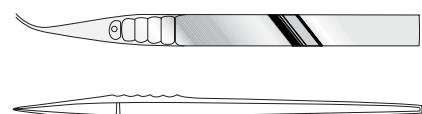

125mm long

Code	Description
SC-GI/066	Straight
SC-GI/067	Curved



Gillies Dissecting Forceps

1-2 teeth

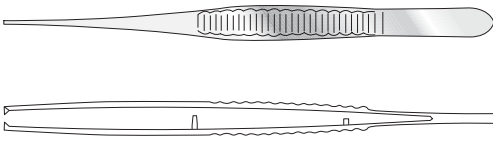

Code	Description
SC-PL/052	152mm long

McIndoe Dissecting Forceps

152mm long

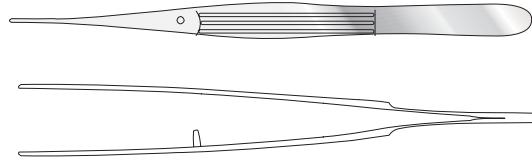

Code	Description
SC-GI/476	Serrated
SC-GI/477	1-2 teeth

Jackson Burrows Dissecting Forceps

140mm long

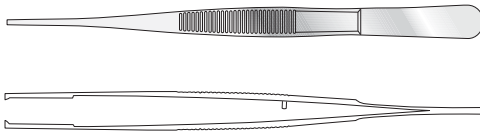

Code	Description
SC-OR/N037	Tongue and groove, 1-2 teeth
SC-OR/N037a	Tongue and groove only

152mm long, 1mm tip, modified for fine powerful dissection with strong action tip

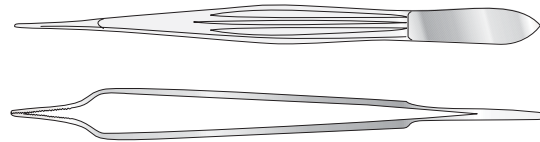

Code	Description
SH/5961	Serrated

Jean Dissecting Forceps

Serrated jaws, 140mm long

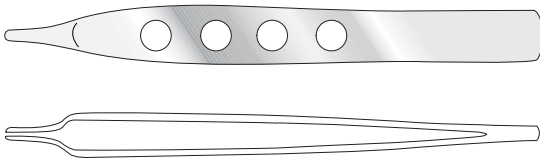

Code	Description
SC-GI/269	Fine
SC-GI/270	1-2 teeth
SC-GI/271	2-3 teeth, 178mm long

Treves Dissecting Forceps

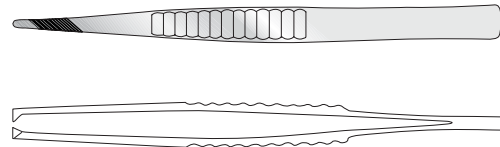

1-2 teeth

Code	Description
SC-GI/251	127mm long
SC-GI/252	152mm long

2-3 teeth

Code	Description
SC-GI/253	127mm long
SC-GI/254	152mm long

Lanes Dissecting Forceps

1-2 teeth on serrated jaws, 140mm long

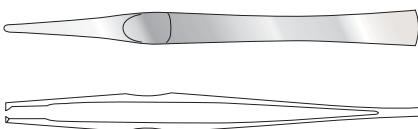

Code	Description
SC-GI/246	127mm long
SC-GI/247	152mm long
SC-GI/248	178mm long

Code	Description
SC-GI/249	2-3 teeth, 178mm long
SC-GI/250	2-3 teeth 203mm long

Waugh Dissecting Forceps

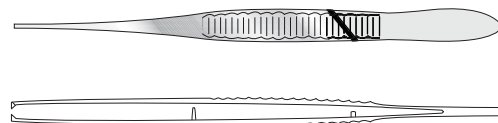

Fine, serrated

Code	Description
SC-GI/261	152mm long
SC-GI/262	178mm long
SC-GI/263	203mm long

Fine, 1-2 teeth

Code	Description
SC-GI/264	152mm long
SC-GI/265	178mm long
SC-GI/266	203mm long



Tissue Forceps

Allis Tissue Forceps

Box joint

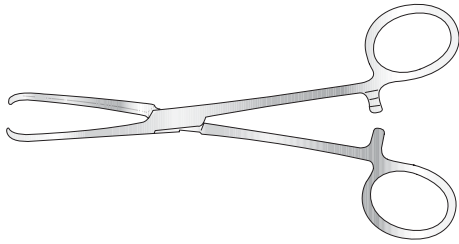

150mm long

Code	Description
SC-GI/272	3-4 teeth
SC-GI/273	4-5 teeth

190mm long

Code	Description
SC-GI/414	5-6 teeth

Duval Tissue Forceps

Box joint

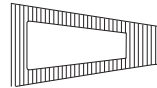
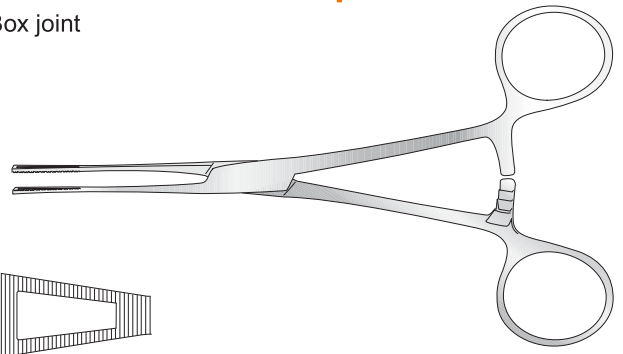

Code	Description
SC-GI/279	13mm wide, 203mm long

Littlewood Tissue Forceps

Box joint, 2-3 teeth

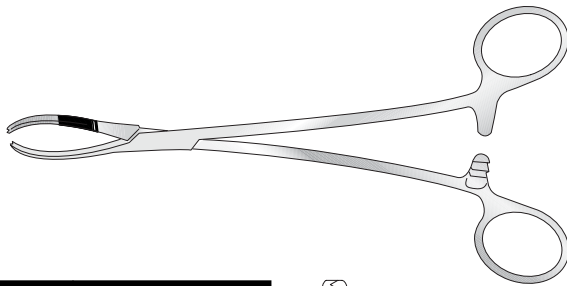

Code	Description
SC-GI/275	190mm long



Lane Tissue Forceps

Box joint, 1-2 teeth, fenestrated

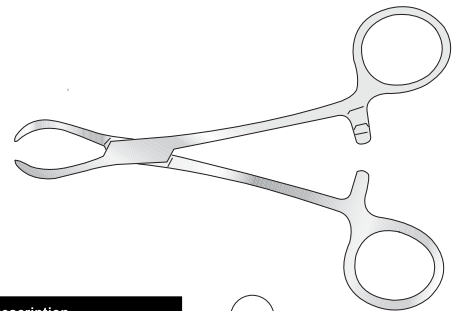

Code	Description
SC-GI/280	127mm long
SC-GI/281	152mm long
SC-GI/282	197mm long



Babcock Tissue Forceps

Box joint, serrated jaws

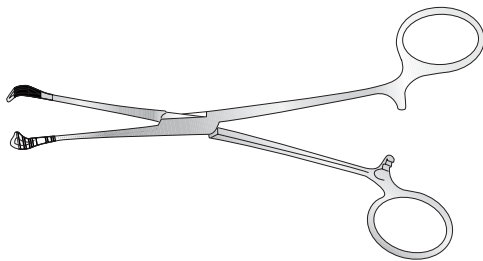

Code	Description
SC-GI/276	160mm long
SC-GI/277	200mm long
SC-GI/278	230mm long

Rutherford Morrison Tissue Forceps

Box joint

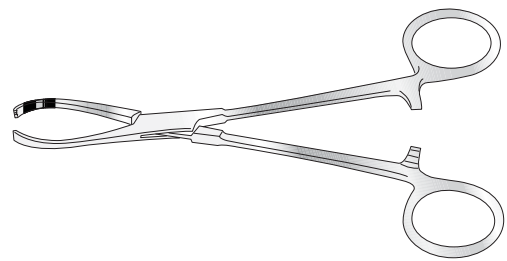

Code	Description
SC-GI/283	4-5 teeth, 152mm long





Our Offer

ON SSD ESSENTIALS PACK

Top up your trays with these essentials...

CONTACT For OFFER PRICE

Halstead Mosquito Forceps

Straight/Curved
125mm (5")

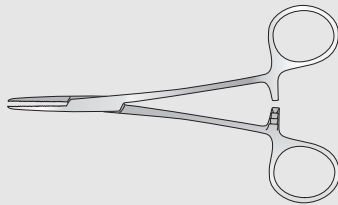

Ramsey Sponge Holding Forceps

Straight, Serrated
Jaws 241mm
(9½ ")

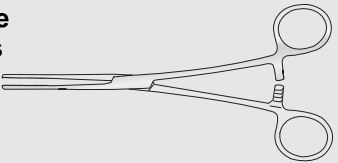

Scalpel Blade Handle

No. 3

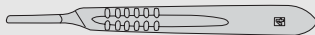

Spring Clip

Serrated Pattern,
Stainless Steel for
Fixing Slings to Leg
Splints, also for
Towel Clipping
6.3cm (2½") Wide

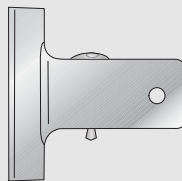

Spencer Wells Artery Forceps

Straight, Serrated
Jaws

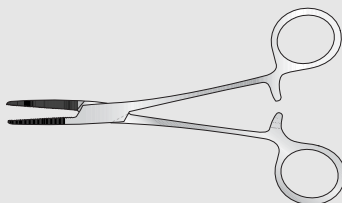

Email us to place your order

info@forgefieldinternational.com

Shaw Tissue Forceps

Box joint

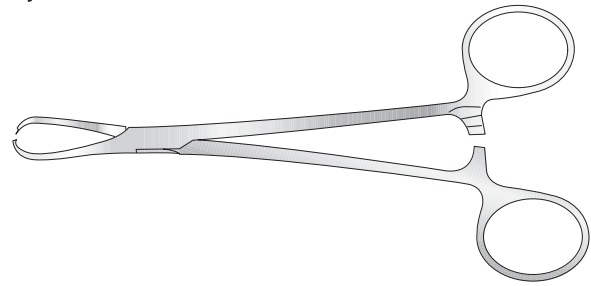

Code	Description
SC-GI/458	1-2 teeth, 178mm long



Guys Gallabin Suture-Holding Forceps

Screw joint, angled flat blades

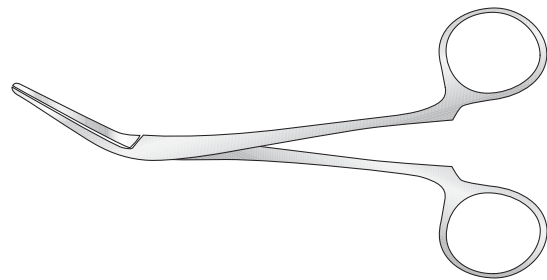

Code	Description
SC-GI/450	125mm long
SC-GI/4402	150mm long

Russian Dissecting Forceps

With fenestrated end



Code	Description
SC-GI/SH-5503b	150mm long
SC-GI/SH-5503	200mm long
SC-GI/403	230mm long
SC-GI/SH-5503a	250mm long





Sponge Holding and Sterilising Forceps

Rampley Sponge Holding Forceps

Box joint, straight, serrated jaws

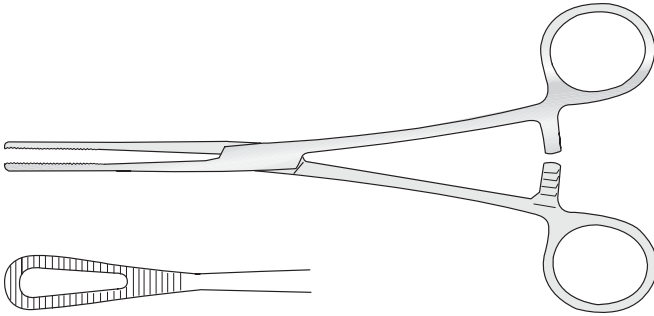

Code	Description
SC-GI/353	178mm long
SC-GI/354	241mm long

Lister Sinus Forceps

Box joint, serrated tip

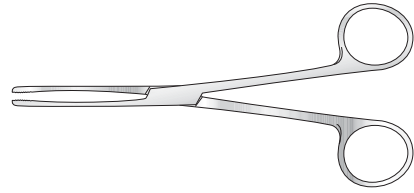

Code	Description
SC-GI/367	127mm long
SC-GI/368	152mm long
SC-GI/369	178mm long

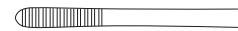

Foerster Sponge Holding Forceps

Box joint, straight, serrated jaws

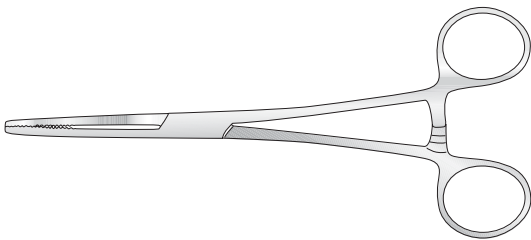

Code	Description
SC-GI/354a	178mm long

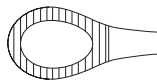

Cheatle Sterilizer Forceps

Screw joint

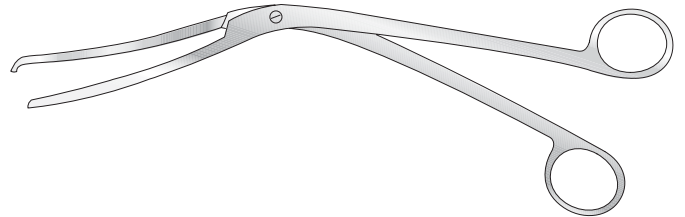

Code	Description
SC-GI/364	267mm long

Harrison Bowl Steriliser Forceps

Screw joint, angled, double jaw

Code	Description
SC-GI/365	356mm long
SC-GI/366	457mm long

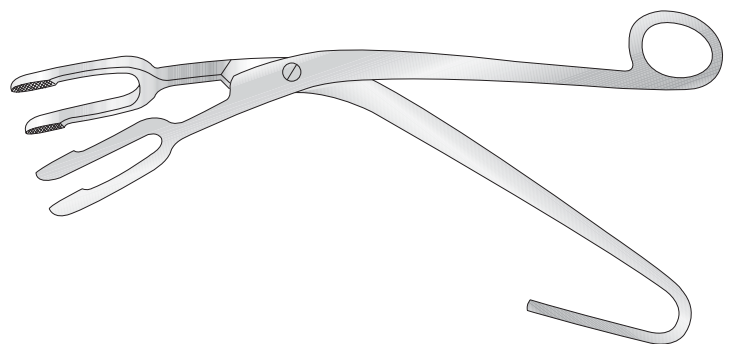

Hunter Splinter Forceps

Serrated grooved pointed jaws



Code	Description
SC-GI/360	115mm long

Michel Forceps

Box joint, double-ended, for inserting and removing clips stainless steel

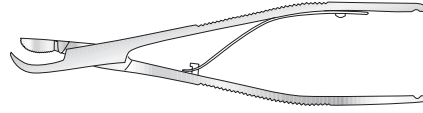

Code	Description
SC-GI/357	130mm long

Michel Skin Holding Forceps

With magazine for Michel clips

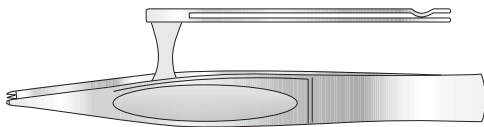

Code	Description
SC-GI/358	1-2 teeth, 127mm long

Michel Clip Extracting Forceps

Box joint

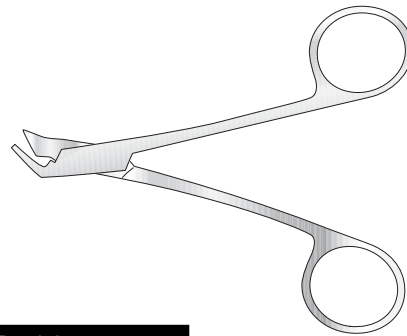

Code	Description
SC-GI/359	125mm long

Childe Approximating Forceps

With magazine for Michel clips

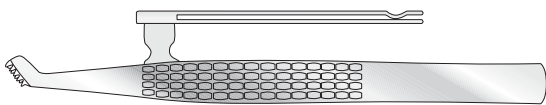

Code	Description
SC-GI/469	180mm long

Robins Anchoring Forceps

140mm long

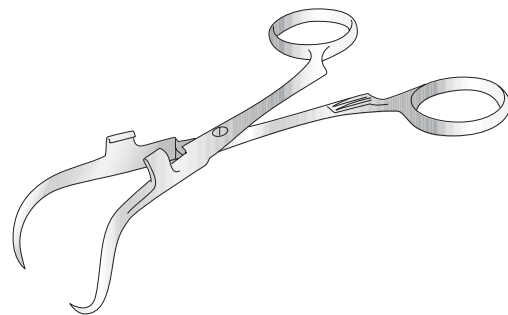

Code	Description
SC-GI/453	5mm with holder for diathermy leads
SC-GI/453a	13mm with holder for suction tubing



Premium Quality Stainless Steel Scissors

Dressing Scissors

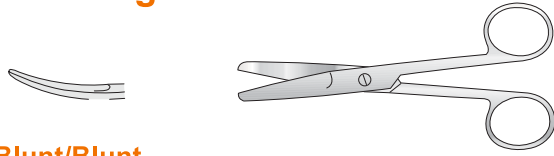

Blunt/Blunt

Straight

Code	Description
SC-GI/133	130mm long
SC-GI/136	146mm long
SC-GI/139	165mm long

Curved

Code	Description
SC-GI/142	130mm long
SC-GI/143	146mm long
SC-GI/144	165mm long
SC-GI/145	185mm long
SC-GI/404	147mm long

With one serrated blade

Blunt/Sharp

Straight

Code	Description
SC-GI/134	130mm long
SC-GI/137	146mm long
SC-GI/140	165mm long

Sharp/Sharp

Straight

Code	Description
SC-GI/135	130mm long
SC-GI/138	146mm long
SC-GI/141	165mm long

Curved

Code	Description
SC-GI/146	130mm long

Metzenbaum Scissors

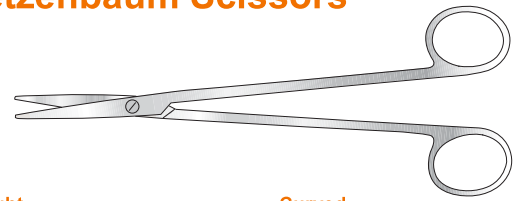

Straight

Code	Description
SC-GI/405	180mm long
SC-GI/406	147mm long
SC-GI/406a	200mm long
SC-GI/406b	230mm long
SC-GI/406c	250mm long
SC-GI/406d	280mm long

Curved

Code	Description
SC-GI/407	185mm long
SC-GI/408	147mm long
SC-GI/408a	200mm long
SC-GI/408b	230mm long
SC-GI/408c	250mm long
SC-GI/408d	280mm long

Dressing Scissors, Left-Handed

With one black bow, 145mm long

Blunt/Blunt

Code	Description
SC-GI/192	Straight
SC-GI/193	Curved

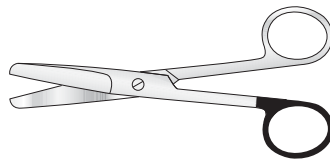

Blunt/Sharp

Code	Description
SC-GI/194	Straight
SC-GI/195	Curved

Sharp/Sharp

Code	Description
SC-GI/196	Straight
SC-GI/197	Curved

Mayo Scissors



Straight

Code	Description
SC-GI/409	140mm long
SC-GI/409a	160mm long
SC-GI/411	190mm long
SC-GI/411a	230mm long

Curved

Code	Description
SC-GI/410	140mm long
SC-GI/410a	160mm long
SC-GI/412	190mm long
SC-GI/412a	230mm long

Little Dissecting Scissors

Fine pattern, with eye for suture

Code	Description
SC-PL/001f	115mm long

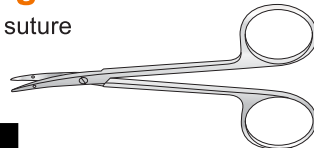

Fergusson Scissors

Angled on flat

Code	Description
SC-GI/148	180mm long

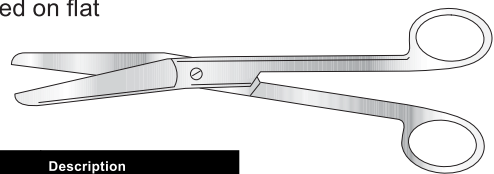

Paynes Suture Scissors

Code	Description
SC-GI/152	100mm long



Kilner Dissecting Scissors

Fine pattern

Code	Description
SC-PL/001a	115mm long



Ligature Stitch Scissors

Fine pattern

Code	Description
SC-GI/153	115mm long

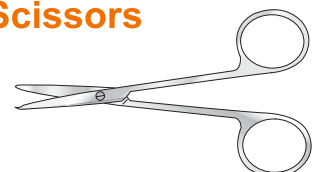

Lister Bandage Scissors

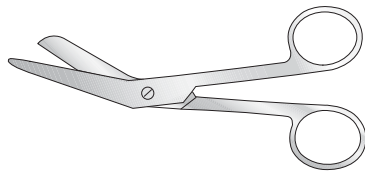

Code	Description
SC-GI/154	147mm long
SC-GI/155	178mm long

Lister Bandage Scissors

Angled, with probe end

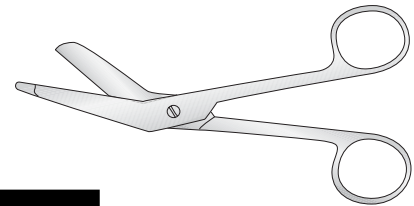

Code	Description
SC-GI/361	147mm long
SC-GI/362	178mm long

McIndoe Scissors

178mm long

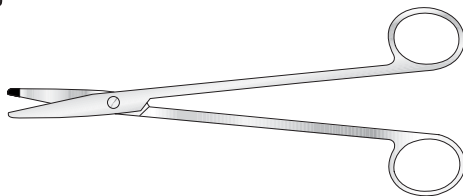

Code	Description
SC-GI/149	Straight
SC-GI/150	Curved on flat
SC-GI/150sc	Supercut, curved



Thomas Strabismus Scissors

114mm long

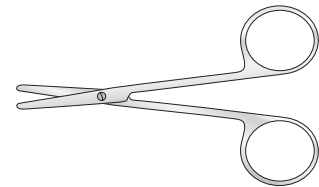

Code	Description
SC-OP/030	Straight
SC-OP/029	Curved

Heath Stitch Scissors

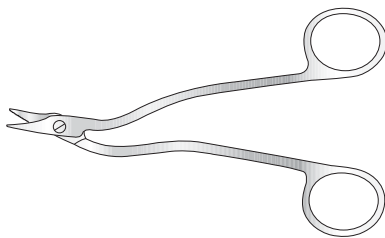

Code	Description
SC-GI/151	152mm long

“Careless” Scissors

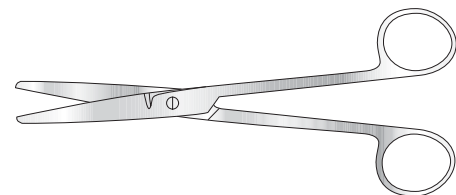

Code	Description
SC-GI/474	165mm long

Tubing Scissors

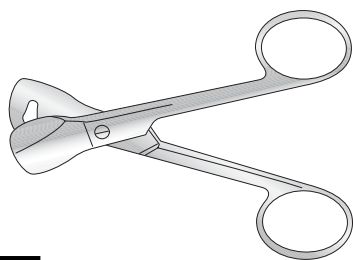

Code	Description
SC-GI/147	130mm long

Utility Scissors



Code	Description
SC-GI/466	190mm long



Tungsten Carbide Hard Insert Scissors

Dressing Scissors

Tungsten carbide hard insert, blunt/blunt

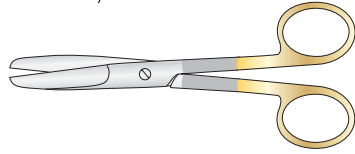

Straight

Code	Description
SC-GI/430	130mm long
SC-GI/432	145mm long
SC-GI/434	165mm long
SC-GI/436	185mm long

Curved

Code	Description
SC-GI/431	130mm long
SC-GI/433	145mm long
SC-GI/435	165mm long

Mayo Dressing Scissors

Tungsten carbide hard insert

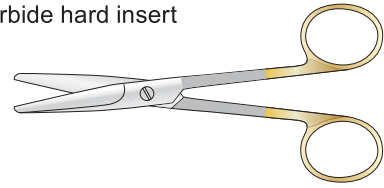

Straight

Code	Description
SC-GI/419	140mm long
SC-GI/419a	160mm long
SC-GI/421	190mm long
SC-GI/421a	230mm long

Curved

Code	Description
SC-GI/420	140mm long
SC-GI/420a	160mm long
SC-GI/422	190mm long
SC-GI/422a	230mm long

Dressing Scissors

Tungsten carbide hard insert, blunt/sharp

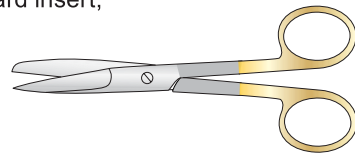

Straight

Code	Description
SC-GI/423	130mm long
SC-GI/425	145mm long
SC-GI/427	165mm long
SC-GI/429	185mm long

Curved

Code	Description
SC-GI/424	130mm long
SC-GI/426	145mm long
SC-GI/428	165mm long

Mayo-Harrington Dressing Scissors

Tungsten carbide hard insert

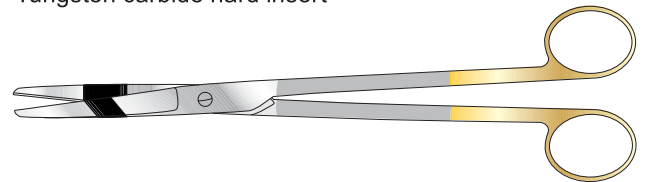

230mm long

Code	Description
SC-GI/417	Straight
SC-GI/418	Curved

200mm long

Code	Description
SC-GI/162a	Straight
SC-GI/413b	Curved

Dressing Scissors

Tungsten carbide hard insert sharp/sharp

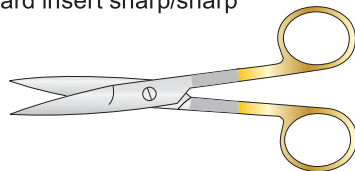

Straight

Code	Description
SC-GI/437	130mm long
SC-GI/439	145mm long
SC-GI/441	165mm long
SC-GI/443	185mm long

Curved

Code	Description
SC-GI/438	130mm long
SC-GI/440	145mm long
SC-GI/442	165mm long

Metzenbaum Scissors

Tungsten carbide hard insert

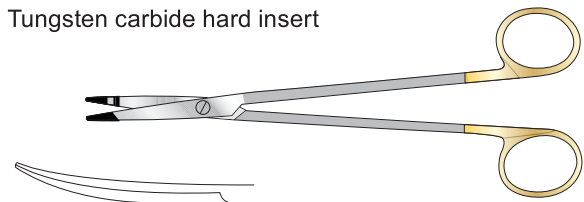

230mm long

Code	Description
SC-GI/445	145mm long
SC-GI/448	185mm long
SC-GI/471a	230mm long
SC-GI/471b	250mm long
SC-GI/471c	280mm long

200mm long

Code	Description
SC-GI/446	145mm long
SC-GI/449	185mm long
SC-GI/449a	200mm long
SC-GI/449b	230mm long
SC-GI/449c	250mm long
SC-GI/449d	280mm long

Baby Metzenbaum Scissors

Tungsten carbide, hard insert, 145mm long

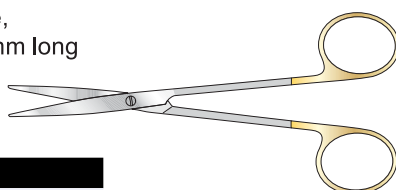

Code	Description
SC-GI/445a	Straight
SC-GI/446a	Curved

Ligature Scissors

Tungsten carbide hard insert, curved

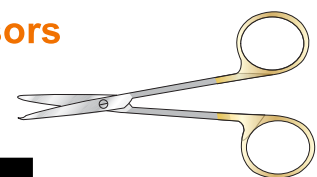

Code	Description
SC-GI/444	145mm long
SC-GI/447	185mm long



Tungsten Carbide Supercut Scissors

Mayo Harrington Scissors

Supercut, tungsten carbide

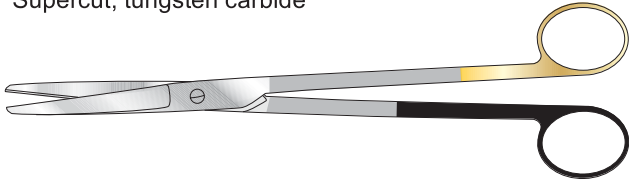

230mm long

Code	Description
SC-GI/162	Straight
SC-GI/413	Curved

200mm long

Code	Description
SC-GI/162b	Straight
SC-GI/413b	Curved

Dressing Scissors

Supercut, tungsten carbide

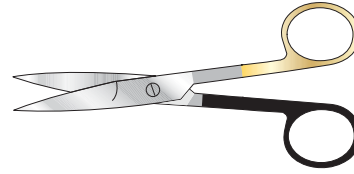

Blunt/Blunt

Straight

Code	Description
SC-GI/174	130mm long
SC-GI/176	145mm long
SC-GI/178	165mm long
SC-GI/180	185mm long

Curved

Code	Description
SC-GI/175	130mm long
SC-GI/177	145mm long
SC-GI/179	165mm long
SC-GI/180a	185mm long

Mayo Scissors

Supercut, tungsten carbide

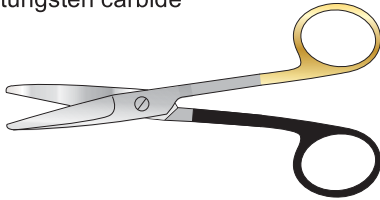

Straight

Code	Description
SC-GI/163	140mm long
SC-GI/163a	160mm long
SC-GI/165	190mm long
SC-GI/165a	230mm long

Curved

Code	Description
SC-GI/164	140mm long
SC-GI/164a	160mm long
SC-GI/166	190mm long
SC-GI/166a	230mm long

Blunt/Sharp

Straight

Code	Description
SC-GI/167	130mm long
SC-GI/169	145mm long
SC-GI/171	165mm long
SC-GI/173	185mm long

Curved

Code	Description
SC-GI/168	130mm long
SC-GI/170	145mm long
SC-GI/172	165mm long
SC-GI/173a	185mm long

Sharp/Sharp

Straight

Code	Description
SC-GI/181	130mm long
SC-GI/183	145mm long
SC-GI/185	165mm long
SC-GI/187	185mm long

Curved

Code	Description
SC-GI/182	130mm long
SC-GI/184	145mm long
SC-GI/186	165mm long
SC-GI/187a	185mm long

GUIDE FOR GOLD AND BLACK BOWS

KNOW THE DIFFERENCE



2 Gold Bows
Tungsten carbide insert or padding for a scissor



2 Black Bows
Supercut edge



1 Black and 1 Gold Bow
Supercut tungsten carbide



1 Black Bow (left ring)
Left-handed instrument

Metzenbaum Dissecting Scissors

Supercut, tungsten carbide

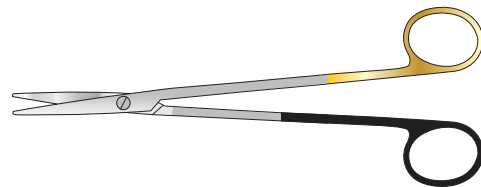

Straight

Code	Description
SC-GI/188tc	185mm long
SC-GI/188tca	200mm long
SC-GI/188tcb	230mm long
SC-GI/188tcc	250mm long
SC-GI/188tcd	280mm long

Curved

Code	Description
SC-GI/191tc	147mm
SC-GI/189tc	185mm
SC-GI/186tca	200mm
SC-GI/188tcb	230mm
SC-GI/188tcc	250mm
SC-GI/188tcd	280mm



Supercut Operating Scissors

Dressing Scissors

Supercut, blunt/blunt

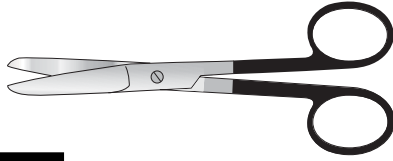

145mm long

Code	Description
SC-GI/160	Straight
SC-GI/161	Curved

Dressing Scissors

Supercut, blunt/sharp

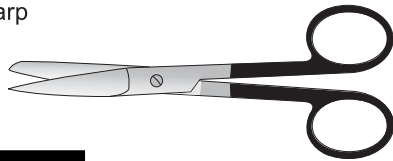

145mm long

Code	Description
SC-GI/156	Straight
SC-GI/157	Curved

Dressing Scissors

Supercut, sharp/sharp

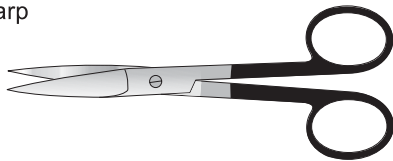

145mm long

Code	Description
SC-GI/158	Straight
SC-GI/159	Curved

Mayo Scissors

Supercut

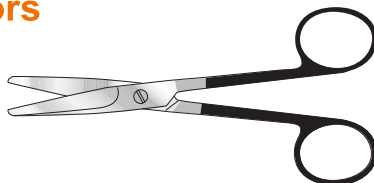

Straight

Code	Description
SC-GI/166a	140mm long
SC-GI/166e	160mm long
SC-GI/166b	170mm long

Curved

Code	Description
SC-GI/166c	140mm long
SC-GI/166f	160mm long
SC-GI/166d	170mm long

Boyd Scissors

Supercut, blunt/blunt

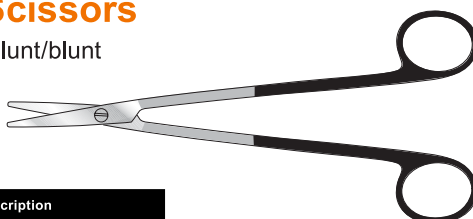

Code	Description
SC-THO/047	180mm long

Metzenbaum Dissecting Scissors

Supercut

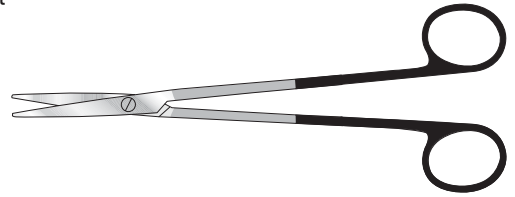

Straight (length)

Code	Description
SC-GI/190	147mm
SC-GI/188	185mm
SC-GI/188a	200mm
SC-GI/188b	230mm
SC-GI/188c	250mm
SC-GI/188d	280mm

Curved (length)

Code	Description
SC-GI/191	147mm
SC-GI/189	185mm
SC-GI/186a	200mm
SC-GI/186b	230mm
SC-GI/186c	250mm
SC-GI/186d	280mm

Stevens Tenotomy Scissors

Supercut



Curved/blunt

Code	Description
SC-OP/424	114mm long
SC-OP/424a	125mm long
SC-OP/424gb	135mm long

Curved/sharp

Code	Description
SC-OP/425	114mm long
SC-OP/425a	140mm long
SC-OP/425b	160mm long

Code	Description
SC-OP/426	Straight/blunt, 114mm long
SC-OP/427	Straight/sharp, 114mm long
SC-OP/427c	Straight/sharp, 180mm long

With cutout, 110mm long

Code	Description
SC-OP/427a	Straight/blunt
SC-OP/427b	Curved/blunt

Strabismus Scissors

Supercut



114mm long

Code	Description
SC-GI/475	Straight
SC-GI/475a	Curved

Iris Scissors

Supercut

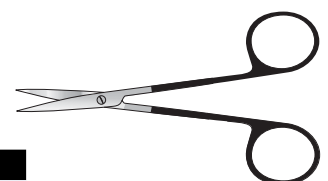

114mm long

Code	Description
SC-OP/476	Straight
SC-OP/476a	Curved



Bruce Clarke Needle Holder

Screw joint

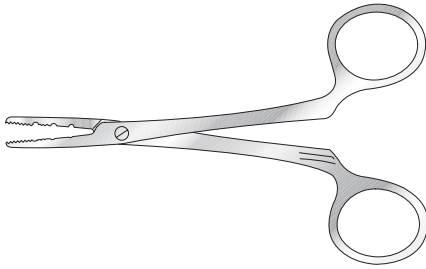

Code	Description
SC-GI/205	127mm long

Lawrence Needle Holder

Fine jaw, 150mm long

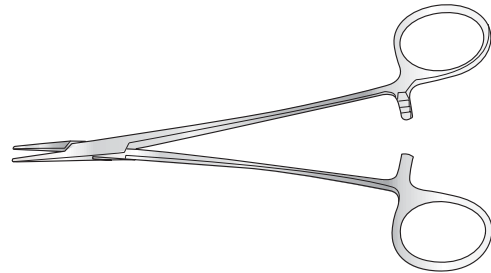

Code	Description
SC-PL/012a	
SC-PL/012b	Tungsten carbide jaw

Crile-Wood Needle Holder

Straight, baby, fine

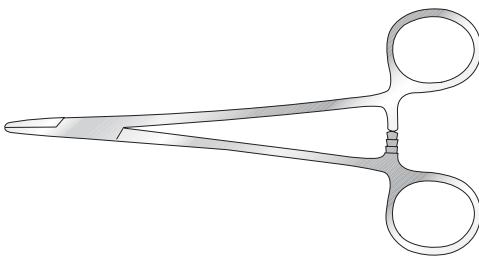

Code	Description
SC-GI/199	150mm long

Needle Holder

Surgical Holdings pattern, box joint, lightweight, with curved plain jaws and one oset bow for thumb

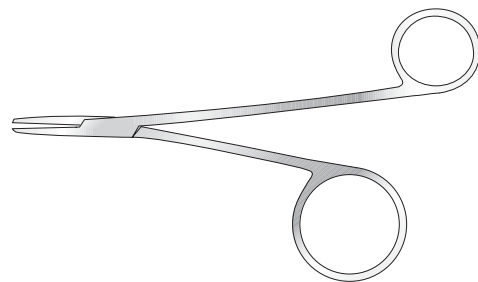

Code	Description
SC-GI/209	152mm long

Kilner Needle Holder

Box joint, cross-serrated jaw

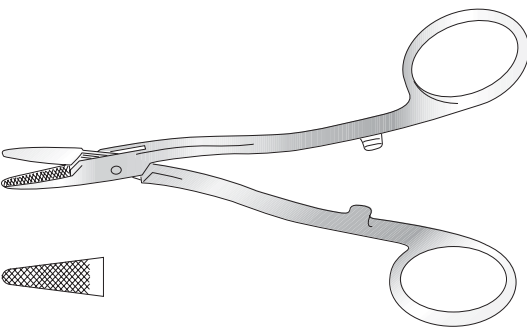

Code	Description
SC-GI/200	165mm long
SC-GI/201	133mm long

MacPhail Needle Holder

Screw joint, with one copper jaw

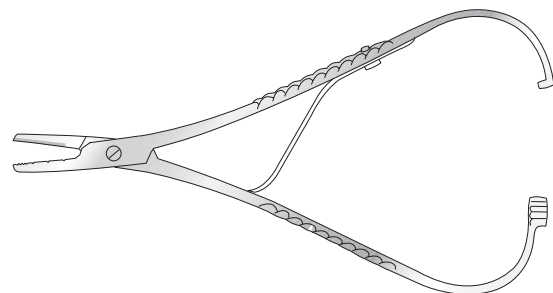

Code	Description
SC-GI/206	159mm long
SC-GI/207	178mm long
SC-GI/208	209mm long



Needle Holders

Mathieu Needle Holder

Screw joint

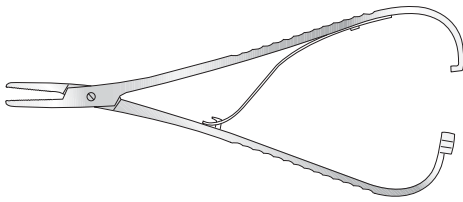

Code	Description
SC-GI/210	172mm long
SC-GI/211	209mm long
SC-GI/212	243mm long

Naughton Morgan Needle Holder

Box joints, cross serrated jaws

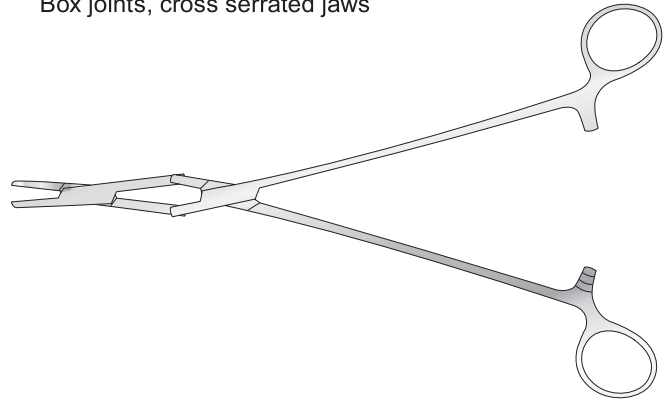

Mayo Needle Holder

Box joint, straight

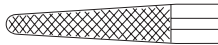
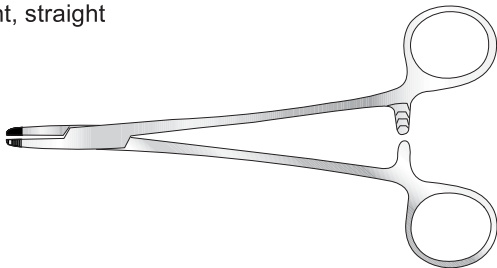

Wide cross serrated jaws

Code	Description
SC-GI/224	159mm long
SC-GI/398	203mm long

Narrow cross serrated jaws

Code	Description
SC-GI/225	159mm long

Tungsten carbide

Code	Description
SC-GI/399	185mm long
SC-GI/400	254mm long

Code	Description
SC-GI/401	185mm long
SC-GI/402	254mm long

Rochester-Mayo Needle Holder

Screw joint

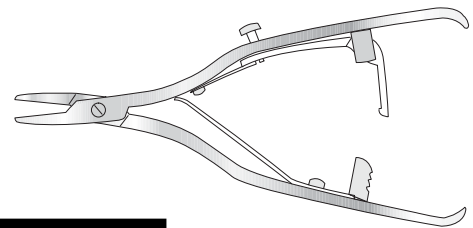

Code	Description
SC-GI/213	178mm long

NEEDLE SIZE GUIDE

Our tungsten carbide inserts are available in a variety of styles. Choosing the most suitable needle size for each procedure helps give the surgeon maximum grip and control.

Coarse 0.65mm

For powerful needle holder patterns and wire twisters. Maximum holding capabilities for heavy needles or wire.



Micro 0.2-0.3mm

For micro needle holders such as Castroviejo, Microvascular and Mini-Ryder. For delicate needles and sutures between 7-0 and 10-0.



Standard 0.5mm

Used, for example, in Mayo-Hegar, Mathieu Needle Holders. For needles 3-0 and larger.



Smooth

Smooth tungsten carbide surface reduces damage to delicate needles and suture of 6-0 and finer.



Fine 0.4mm

For delicate needle holders such as Crile-Wood and DeBakey. For needles and sutures between 4-0 and 6-0.





Tungsten Carbide Needle Holders

Berry Needle Holder/Wire Twister

Tungsten carbide jaws

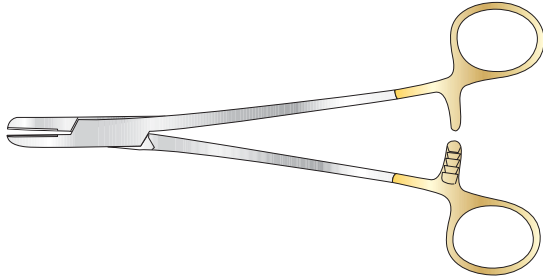

Code	Description
SC-GI/467	200mm long

Finochietto Needle Holder

Tungsten carbide jaws

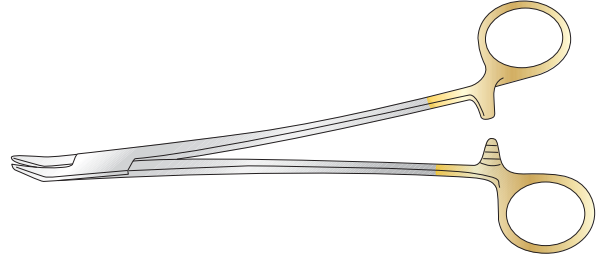

Code	Description
SC-GI/222	215mm long
SC-GI/223	265mm long

Crile-Wood Needle Holder

Tungsten carbide insert, box joint, satin finish, straight

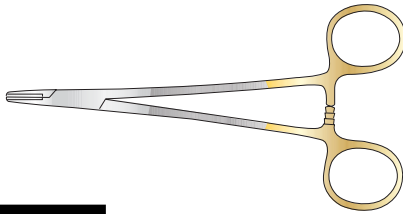

Code	Description
SC-GI/217	159mm long
SC-GI/218	178mm long
SC-GI/198	150mm long

Halsey Needle Holder

Tungsten carbide insert, box joint, satin finish, straight

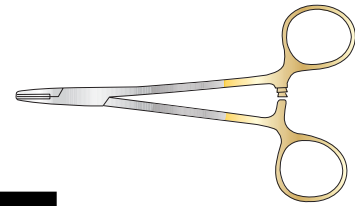

Code	Description
SC-GI/220	127mm long

Derf Needle Holder

Tungsten carbide insert

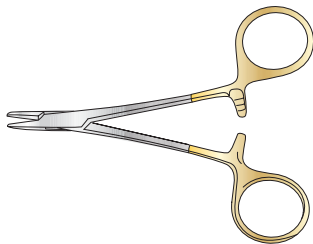

Code	Description
SC-GI/BUPHF002	115mm long

Kilner Needle Holder

Tungsten carbide insert

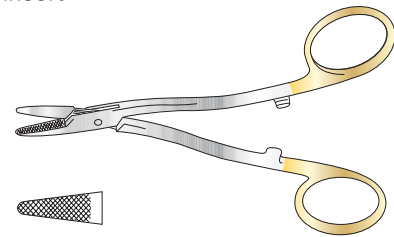

Code	Description
SC-GI/221	140mm long



Tungsten Carbide Needle Holders

Masing Needle Holder

Tungsten carbide insert, one angled bow

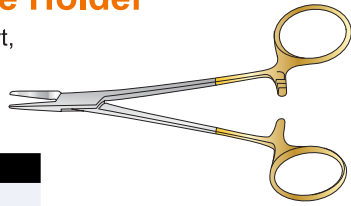

Code	Description
SC-GI/009R	130mm long

Nievert Needle Holder

Tungsten carbide insert, box joint, satin finish, straight

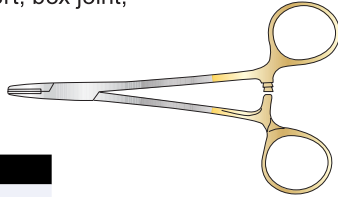

Code	Description
SC-GI/219	127mm long

DeBakey Needle Holder

250mm long

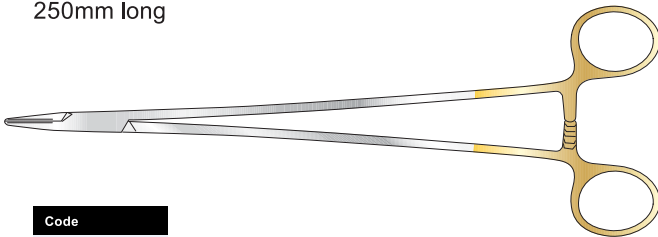

Code
THO/SC-5642a

Mayo-Hegar Needle Holder

Tungsten carbide insert, box joint, satin finish, straight

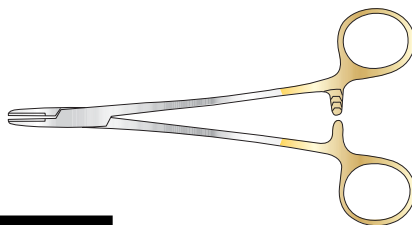

Code	Description
SC-GI/472	130mm long
SC-GI/214	159mm long
SC-GI/215	178mm long
SC-GI/216	209mm long

LONGER SIZES AVAILABLE

Ryder Needle Holder

Tungsten carbide insert, box joint, satin finish, straight

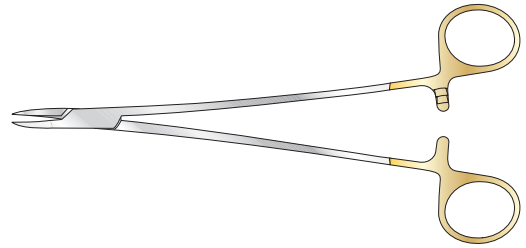

0.2mm jaw pitch

Code	Description
SC-GI/SH-5197a	135mm long
SC-GI/SH-5197b	155mm long
SC-GI/SH-5197c	175mm long
SC-GI/SH-5197d	210mm long

0.4mm jaw pitch

Code	Description
SC-GI/SH-5198a	135mm long
SC-GI/SH-5198b	155mm long
SC-GI/SH-5198c	175mm long
SC-GI/SH-5198d	210mm long

Sarot Needle Holder

Diamond jaw, tungsten carbide, gold plated bows

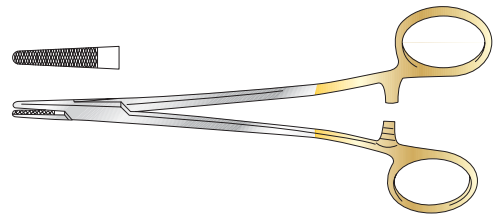

Code	Description
SC-GI/451	181mm long

Tungsten Carbide Needle Holders

Features and Benefits

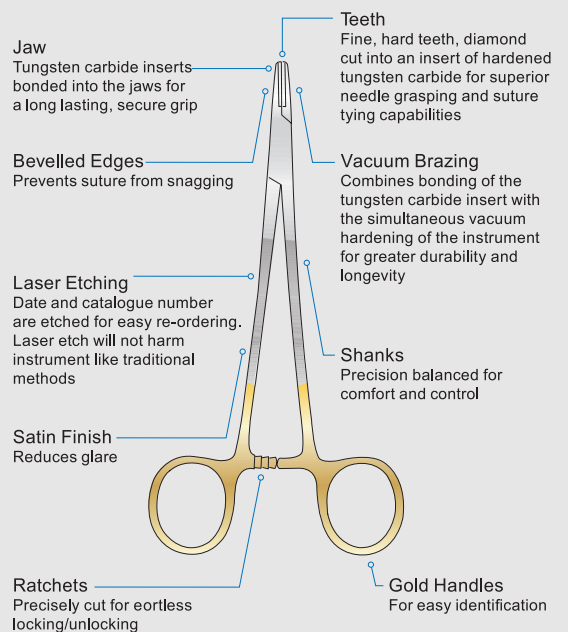



Combined Scissor and Needle Holders

Olsen-Hegar Scissor/Needle Holder

With tungsten carbide insert

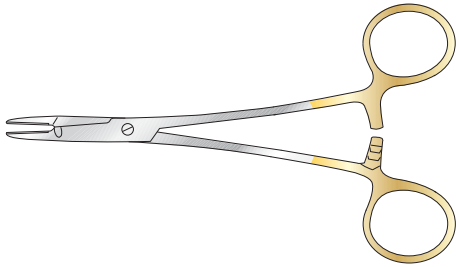

Code	Description
SC-GI/229	147mm long
SC-GI/230	165mm long

Olsen-Hegar Scissor/Needle Holder

Screw joint

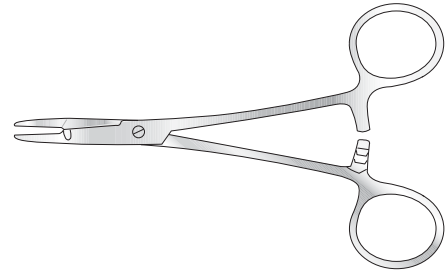

Code	Description
SC-GI/226	140mm long
SC-GI/227	165mm long
SC-GI/228	190mm long

Gillies Scissor/Needle Holder

Right-hand, with tungsten carbide insert

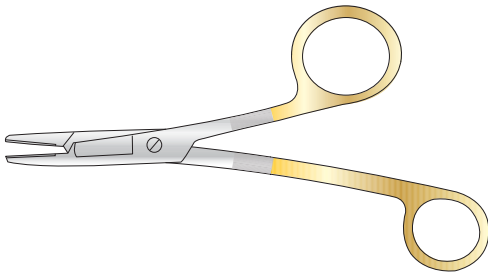

Code	Description
SC-GI/235	158mm long

Gillies Scissor/Needle Holder

Heavy pattern, 158mm long

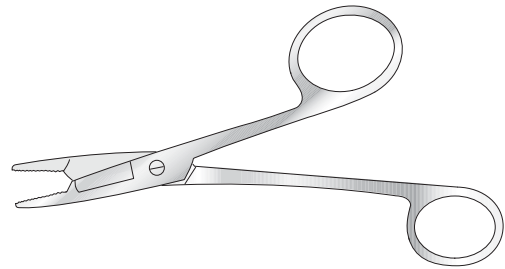

Code	Description
SC-GI/233	Right-hand
SC-GI/234	Left-hand

Gillies Scissor/Needle Holder

158mm long

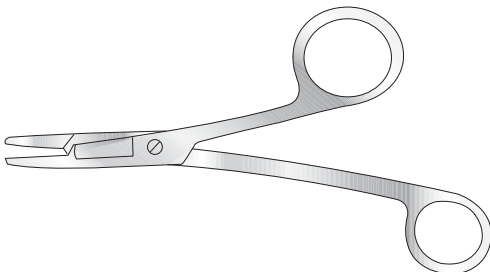

Code	Description
SC-GI/231	Right-hand
SC-GI/232	Left-hand

Foster Gillies Scissor/Needle Holder

Fine pattern

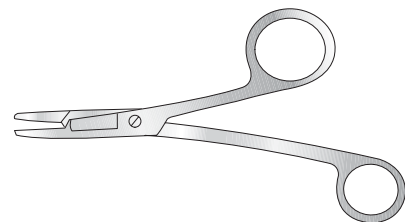

Code	Description
SC-GI/236	127mm long



Bag and Towel Clips

Spring Clip

Serrated pattern, stainless steel, for fixing slings to leg splints, also for towel clipping

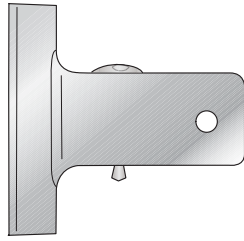

Code	Description
SC-GI/344	63mm wide

Backhaus Towel Clip

Superior quality, box joint

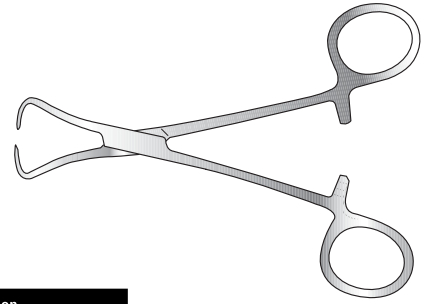

Code	Description
SC-GI/348	89mm long
SC-GI/348a	102mm long
SC-GI/349	130mm long

Spring Bag Clip

Serrated

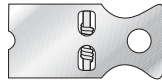

Code	Description
SC-GI/345	26mm wide

Moynihan Towel Clip

Screw joint, 2-2 teeth, for sides of incision

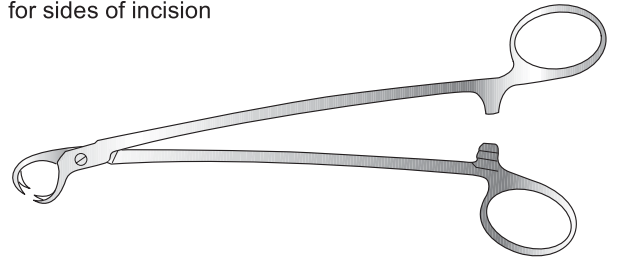

Code	Description
SC-GI/470	191mm long

Jones Towel Clip

Superior quality spring forcep type

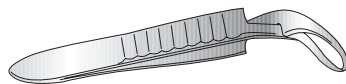

Code	Description
SC-GI/346	89mm long

Ball and Socket Towel Forceps

Box joint

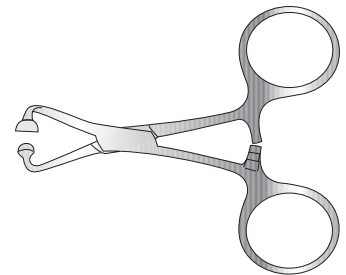

Code	Description
SC-GI/350	89mm long
SC-GI/351	115mm long
SC-GI/352	140mm long

Shardles Towel Clip

Spring curved, cross action

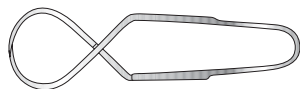

Code	Description
SC-GI/347	77mm long



Goligher Retractor

Complete with 2 centre blades:
 1 x 90mm wide x 50mm deep
 1 x 90mm wide x 90mm deep

and 2 pairs of lateral blades:
 1 pair 25mm wide x 45mm deep
 1 pair 50mm wide x 90mm deep

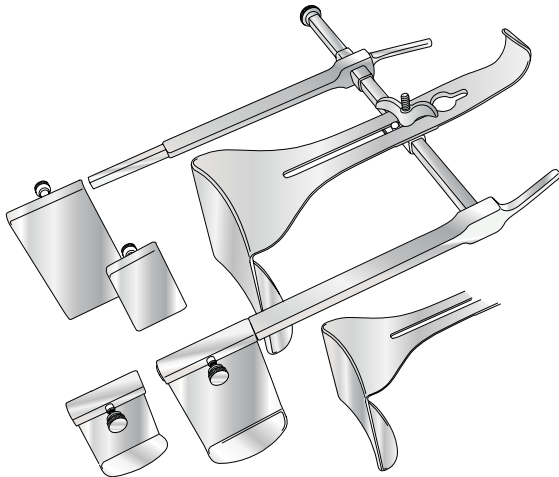

Code
SC-GI/305

Balfour Abdominal Retractor

Trivalve, frame 203mm

Child

102mm opening, 51mm deep lateral blades,
 38mm deep centre blade

Adult

178mm opening, 64mm deep lateral blades,
 44mm deep centre blade

Extra large

178mm opening, 102mm deep lateral blades,
 108mm deep centre blade

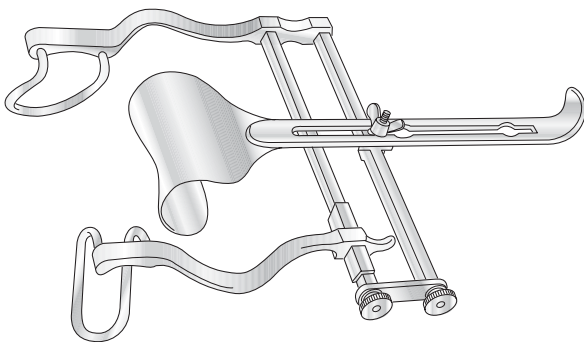

Code	Description
SC-GI/373	Child
SC-GI/374	Adult
SC-GI/375	Extra large

Miles Retractor

Complete with 2 centre blades:
 1 x 90mm wide x 50mm deep
 1 x 90mm wide x 75mm deep

and 2 pairs of lateral blades:
 1 pair 80mm wide x 35mm deep
 1 pair 80mm wide x 75mm deep

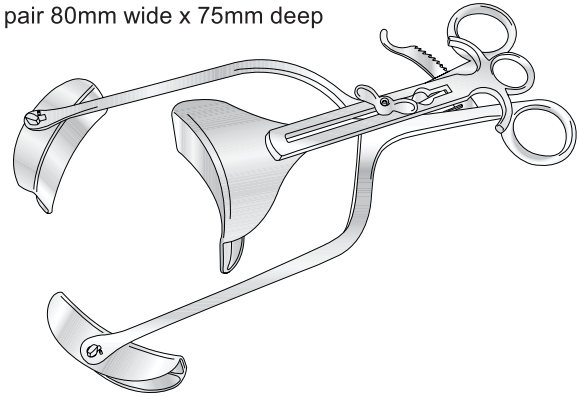

Code	Description
SC-GI/376	340mm long

OTHER BLADE SIZES AVAILABLE

Balfour Abdominal Retractor

Bivalve, baby

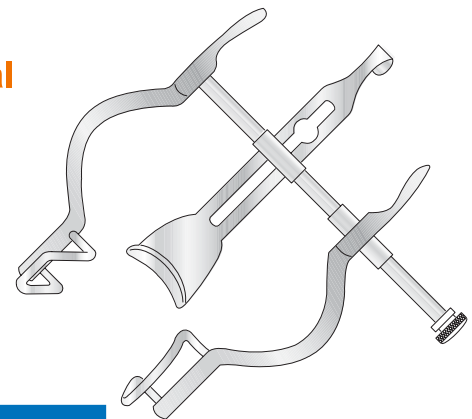

Code	Description
SC-GI/372	Fully open 89mm

Berkeley Abdominal Retractor

Parallel action

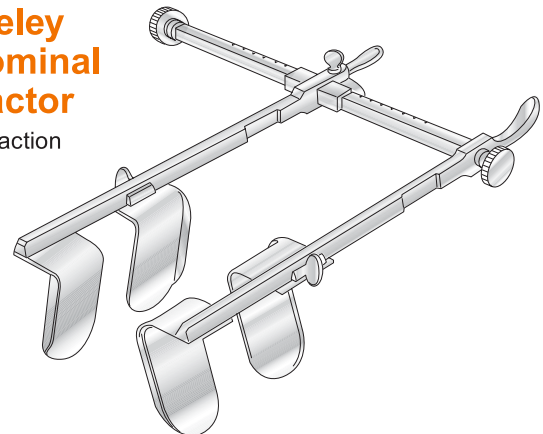

Code	Description
SC-GI/461	Blades 35mm x 60mm deep, 215mm long



Turner Warwick Retractors

Turner Warwick Universal Self Retaining Retractor

Code	Description
SC-GI/520	With frames A/B/C/D and blades A/B/C/D/E/F/K/L
SC-GI/521-A	Circular frame A only 178mm
SC-GI/521-B	Circular frame B only 229mm
SC-GI/521-C	Circular frame C only 305mm
SC-GI/521-D	Oval frame D only 475mm x 330mm
SC-GI/521-E	Oval frame E only 370mm x 300mm

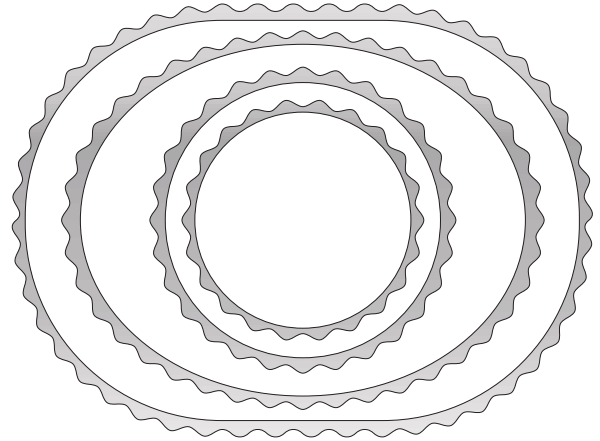

Turner Warwick Needleholder with Tungsten Carbide Jaws

Curved shanks with one short bow

Code	Description
SH-5835	230mm long
SH-5835A	200mm long

Blade A



Code	Description
SC-GI/522-A	Blade only - 19mm x 78mm

Blade B

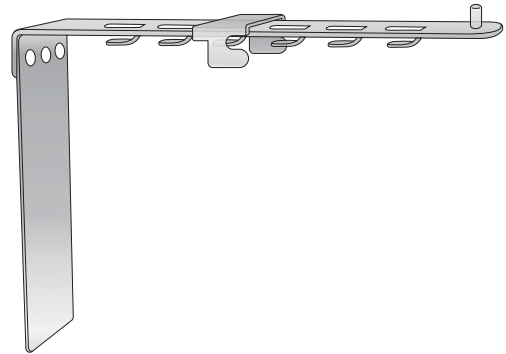

Code	Description
SC-GI/522-B	Blade only - 38mm x 102mm

Blade C

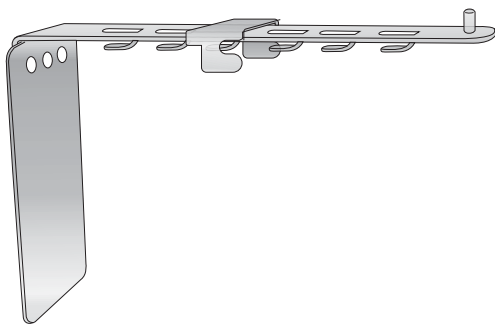

Code	Description
SC-GI/522-C	Blade only - 57mm x 89mm

Blade D

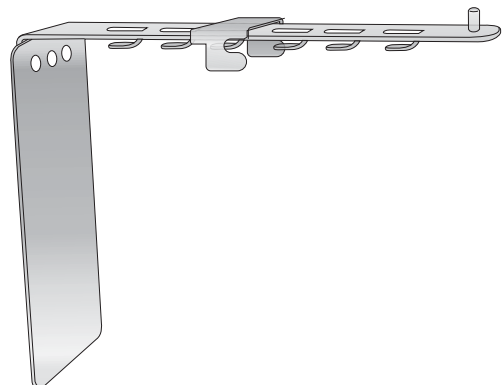

Code	Description
SC-GI/522-D	Blade only - 57mm x 114mm



Turner Warwick Retractors

Blade E

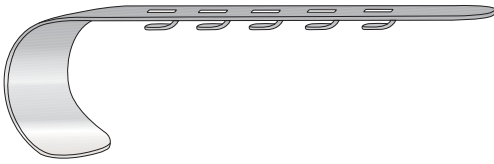

Code	Description
SC-GI/522-E	Blade only - curved stainless steel blade 51mm x 38mm

Blade F

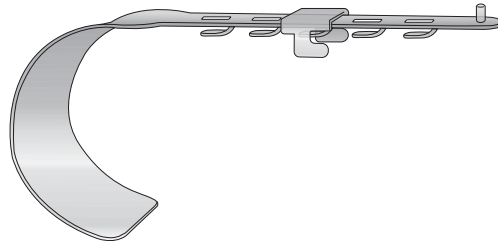

Code	Description
SC-GI/522-F	Blade only - curved stainless steel blade 76mm x 60mm

Blade G

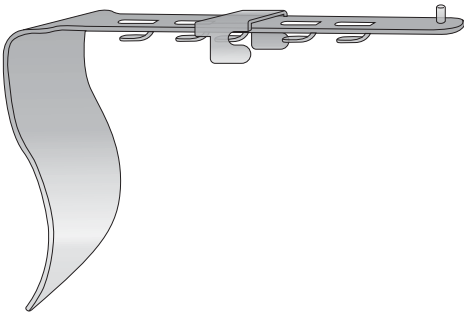

Code	Description
SC-GI/522-G	Blade only - flat stainless steel blade 89mm x 60mm

Blade J

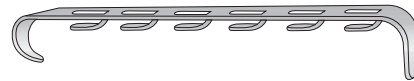

Code	Description
SC-GI/522-J	Blade only - single hook, 13mm deep

Blade K

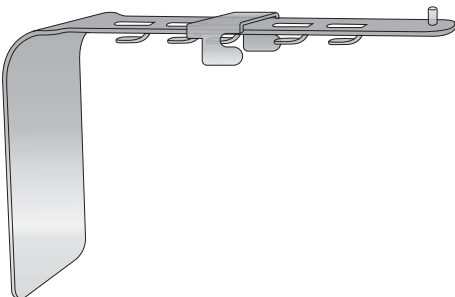

Code	Description
SC-GI/522-K	Blade only - flat with clip 55mm x 90mm

Blade L

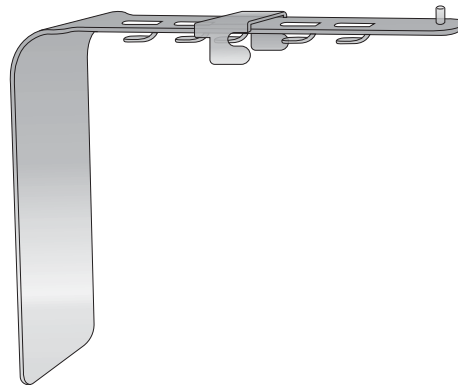

Code	Description
SC-GI/522-L	Blade only - flat with clip 55mm x 120mm



Retractors

Collin Retractor

110mm fully open, 235mm long

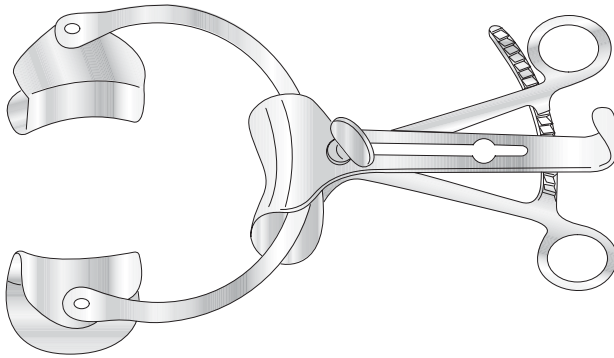

Code	Description
SC-GI/322	Complete with centre blade 55 x 40mm and one pair of blades 38mm x 60mm
SC-GI/322a	Without centre blade

Gelpi Retractor

Self retaining

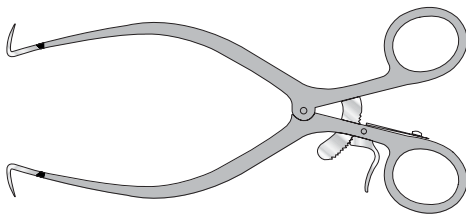

Code	Description
SC-GY/013a	140mm long
SC-GY/013b	178mm long

Joll Thyroid Retractor

Self retaining, with lock-in nut

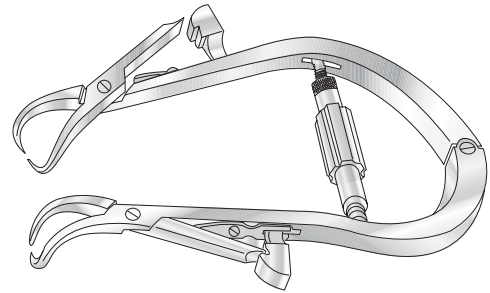

Code	Description
SC-GI/363	152mm long

Gossett Abdominal Retractor

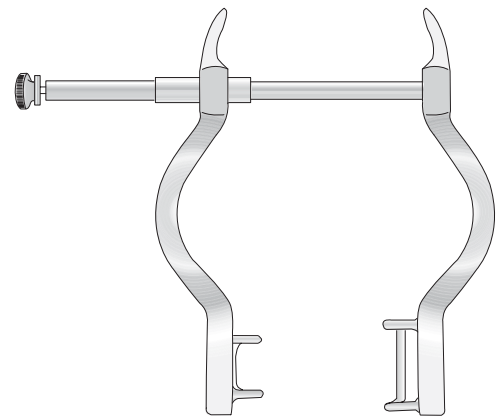

Code	Description
SC-GI/303	Large, fully open 185mm long
SC-GI/304	Small, fully open 95mm long

Pozzi Abdominal Retractors

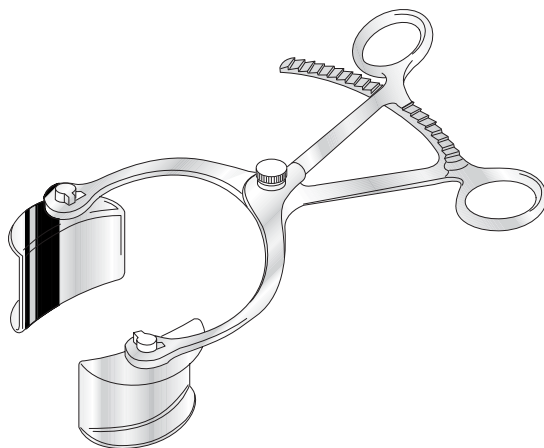

Code	Description
SC-GI/370	Swivel blades: 38 x 60mm, bivalve, 254mm long

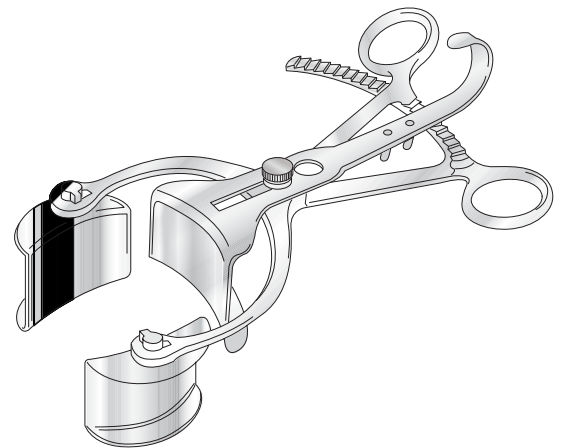

Code	Description
SC-GI/371	Swivel blades: 38 x 59mm, trivalve, 203mm long



Bowlby Dilator

Curved

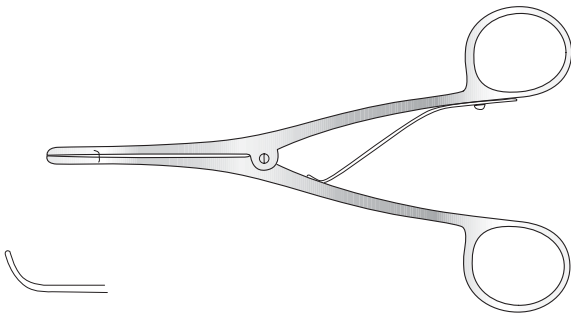

Code	Description
SC-GI/495	145mm long

Travers Retractor

Self retaining with internal rack, 210mm long

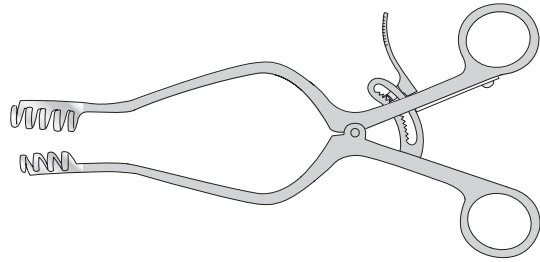

Code	Description
SC-GI/323	4 x 5 teeth, 95mm fully open

Irwin Retractor

Self retaining, with cam rack, 4 x 4 teeth

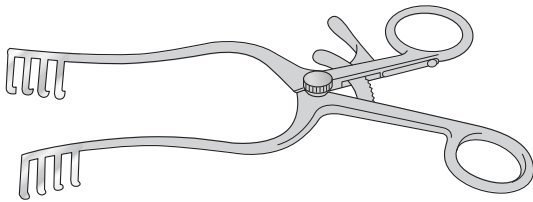

Code	Description
SC-GI/324	178mm long

West Retractor

Self retaining, 140mm long

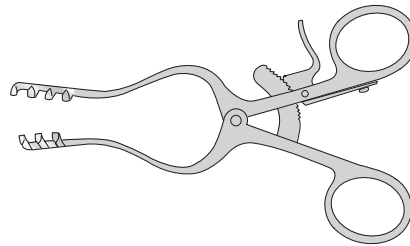

Code	Description
SC-GI/326	3 x 4 teeth, 60mm fully open
SC-GI/326cr	3 x 4 teeth, 60mm fully open, with cam rack

Norfolk and Norwich Retractor

4 x 5 teeth 50mm blades x 223mm long

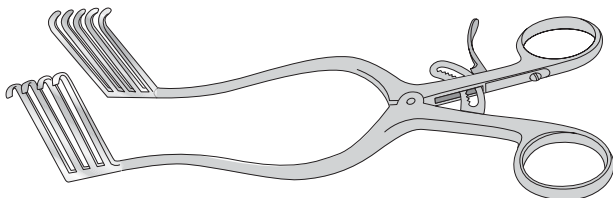

Code	Description
SC-GI/325	Standard rack

Weitlander Retractor

3-4 teeth

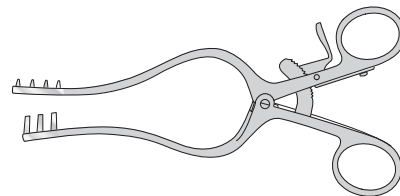

135mm long

Code	Description
SC-GI/496	Blunt
SC-GI/496a	Sharp
SC-GI/496b	Sharp, 2-3 teeth
SC-GI/496c	Blunt, 2-3 teeth

165mm long

Code	Description
SC-GI/497	Blunt
SC-GI/497a	Sharp



Retractors

Kocher Retractor

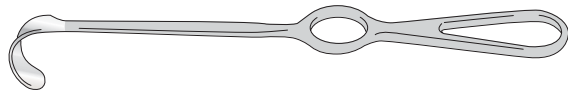

230mm long

Code	Description
SC-GI/378	36 x 20mm blade

250mm long

Code	Description
SC-GI/378a	67 x 25mm blade
SC-GI/378b	80 x 42mm blade
SC-GI/378c	80 x 50mm blade
SC-GI/378d	80 x 60mm blade

Canny Ryall Navy Retractor

Double-ended, with one single hook blade 5mm wide, and one fenestrated blade

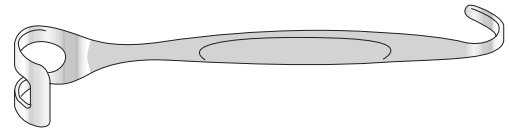

Code	Description
SC-GI/343	Fenestrated blade 16mm wide, 190mm long
SC-GI/343a	Fenestrated blade 19mm wide, 190mm long
SC-GI/343b	Fenestrated blade 25mm wide, 220mm long
SC-GI/343c	Fenestrated blade 30mm wide, 220mm long

Kocher Langenbeck Retractor

215mm long

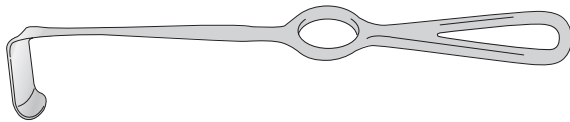

Code	Description
SC-GI/336sp	25 x 6mm blade
SC-GI/379a	35 x 8mm blade
SC-GI/379b	35 x 11mm blade
SC-GI/379c	35 x 15mm blade
SC-GI/357sp	41 x 11mm blade

Code	Description
SC-THO/cutsp015	55 x 11mm blade
SC-GI/379d	70 x 15mm blade
SC-GI/379e	80 x 12mm blade
SC-GI/379f	80 x 16mm blade

Canny Ryall Army Retractor

Double prong, 13mm wide, 165mm long

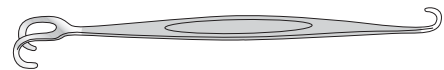

Code	Description
SC-GI/342	Large, 19mm wide
SC-GI/342a	Small, 11mm wide

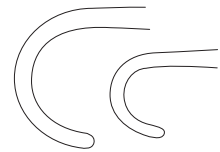

Langenbeck Retractor

Single ended

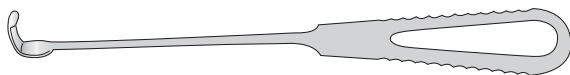

Code	Description
SC-GI/336	Blade 22mm x 6mm
SC-GI/337	Blade 45mm x 13mm
SC-GI/337a	Blade 65mm x 13mm
SC-GI/338a	Blade 75mm x 25mm
SC-GI/338a1	Blade 65mm x 25mm

Czerny Retractor

Double ended

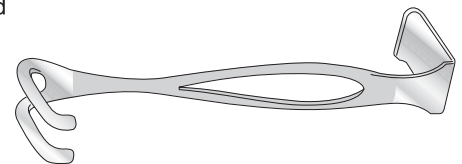

Code	Description
SC-GI/341	171mm long

Landon Retractor

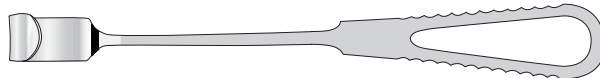

Code	Description
SC-GI/494	230mm



Lane Retractor

Double ended blade, 229mm long

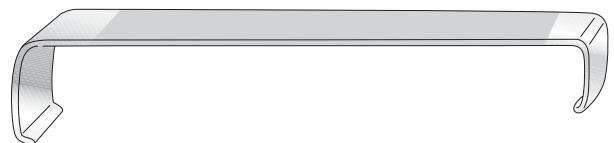

Code	Description
SC-GI/339	13mm x 19mm wide
SC-GI/340	25mm x 32mm wide



Morris Retractor

Single blade, 229mm long

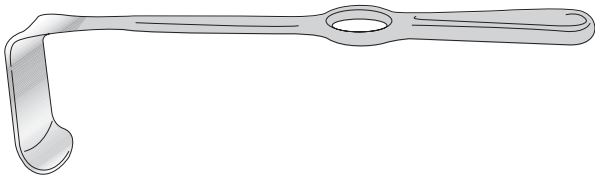

Code	Description
SC-GI/330	38 x 51mm
SC-GI/331	51 x 51mm
SC-GI/332	64 x 51mm

Morris Retractor

Double ended, 216mm long

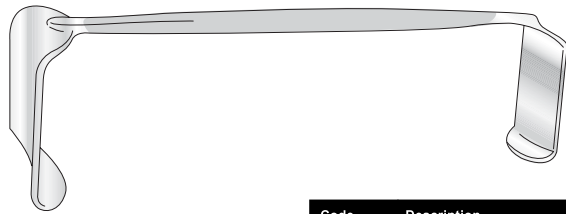

Code	Description
SC-GI/327	32 x 51mm and 38 x 51mm
SC-GI/328	44 x 51mm and 51 x 51mm
SC-GI/329	64 x 51mm and 38 x 51mm

Moyniham Retractor

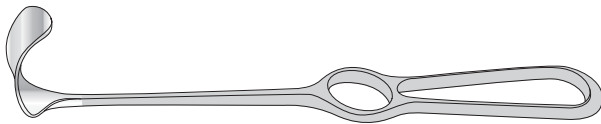

Code	Description
SC-GI/462	Single ended, blade 13 x 22mm, 215mm long

Deaver Abdominal Retractors



Code	Description
SC-GI/306	Set of 5, 315mm overall length
SC-GI/307	25mm wide
SC-GI/308	25mm wide
SC-GI/309	38mm wide
SC-GI/310	51mm wide
SC-GI/311	76mm wide

Elliot (Modified Deaver) Retractor

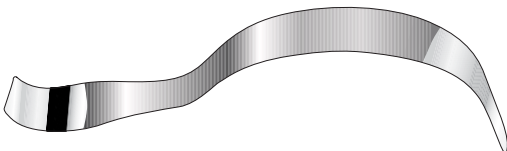

Code	Description
SC-GI/308M	With flat handle

Dyball and Lock Retractor

For liver

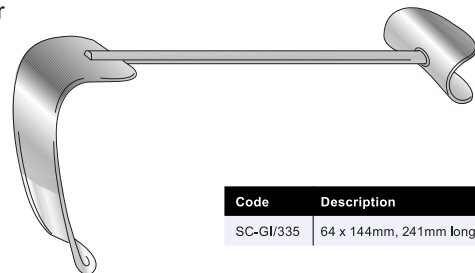

Code	Description
SC-GI/335	64 x 144mm, 241mm long

Deaver Abdominal Retractors

With round handles

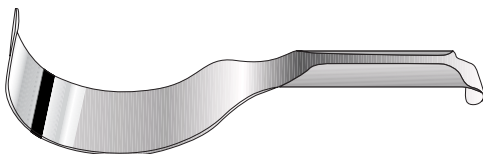

Code	Description
SC-GI/312	Set of 5, 305mm overall length
SC-GI/313	25mm wide
SC-GI/314	25mm wide
SC-GI/315	38mm wide
SC-GI/316	51mm wide
SC-GI/317	76mm wide

Kelly Retractor Blade

267mm long

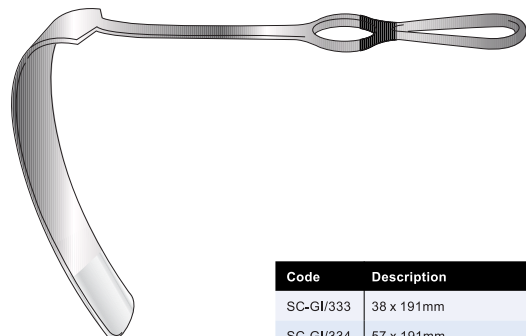

Code	Description
SC-GI/333	38 x 191mm
SC-GI/334	57 x 191mm





Retractors

Durham Retractor

With fenestrated blade, 216mm long

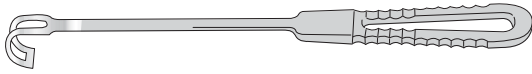

Code	Description
SC-GI/300	10mm wide
SC-GI/301	14mm wide
SC-GI/302	20mm wide

Kocher Retractor



Code	Description
SC-OR/N036c	Sharp, 205mm long
SC-OR/N036	Sharp, 220mm long
SC-OR/N036b	Blunt, 220mm long

Ballance (Volkman) Retractor

203mm long

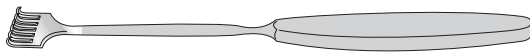

Sharp

Code	Description
SC-GI/463	1 prong
SC-GI/463a	2 prong
SC-GI/463b	3 prong
SC-GI/463c	4 prong
SC-GI/463d	6 prong

Blunt

Code	Description
SC-GI/463e	1 prong
SC-GI/463f	2 prong
SC-GI/463g	3 prong
SC-GI/463h	4 prong
SC-GI/463i	6 prong

Senn-Miller Retractor

170mm long



Code
SC-SH/5881

Single Hook Retractor

Sharp



Code	Description
SC-GI/SH5671	152mm long
SC-PL/065b	Half size, fine

Volkman Retractor



Code	Description
SC-OR/400	Sharp, 220mm long
SC-OR/400a	Blunt, 220mm long
SC-OR/400b	Sharp, 245mm long

Gillies Skin Hook

Solid handle, 190mm long



Code	Description
SC-PL/065a	Standard, fine
SC-PL/065b	Half size, fine

Kilner Retractor

Double ended, cat's paw



Code	Description
SC-PL/056	152mm long

FOR INQUIRY EMAIL US
info@forgefieldinternational.com



Dissectors and Probes

MacDonald Dissector Double Ended Probe, Sinus Silver



Code	Description
SC-GI/285	191mm long



Code	Description
SC-GI/464	152mm long

Brodie Director Probe Ended, Silver Plated



Code	Description
SC-GI/286	165mm long

Probe, Fish Tail Silver Plated



Code	Description
SC-GI/293	127mm long
SC-GI/294	152mm long
SC-GI/295	203mm long
SC-GI/296	254mm long

Watson Cheyne Dissector

Fine, double-ended, with probe end



Code	Description
SC-GI/287	127mm long
SC-GI/288	191mm long
SC-GI/288a	230mm long
SC-GI/288b	288mm long

With one flat tapered end, serrated edge and one small ring end, stainless steel



Code	Description
SC-GI/297	140mm long

Bookwalter® Retractor Kit III

A table-fixed retractor system designed by surgeons to efficiently and reliably hold surgical instruments in place during surgery while allowing greater visibility.

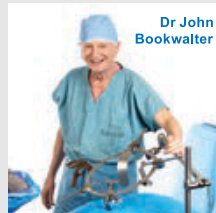

Kit includes Bookwalter® Kit: Table Post and Coupling, Horizontal Flex Bar, Segmented Rings, Tilt Ratchet Mechanism, Kelly Retractors, Blades and Ratchets

Contact us for full details at info@forgefieldinternational.com

Probe, Malleable Silver Plated



Code	Description
SC-GI/289a	127mm long
SC-GI/289	152mm long
SC-GI/290	178mm long
SC-GI/291	203mm long
SC-GI/292	255mm long
SC-GI/292a	305mm long



Miscellaneous

Aneurysm Needle

Small, for infusions



Code	Description
SC-GI/472a	146mm long

Mayo Instrument Pin

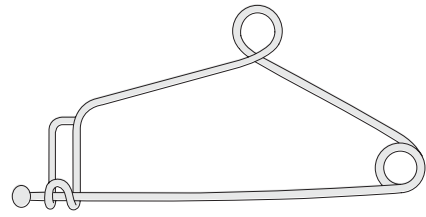

Code	Description
SC-GI/355	102mm long
SC-GI/356	152mm long

Syme Aneurysm Needle

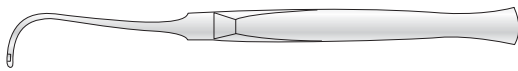

Code	Description
SC-GI/473	165mm long

Baron Scalpel Handle

130mm long



Code	Description
SC-PM/003	No 3
SC-PM/004	No 4

Ring Cutter

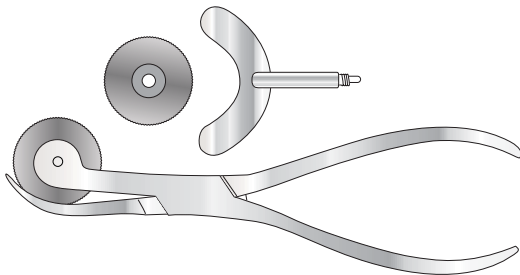

Code	Description
SC-GI/452	Circular saw blade, 165mm long
SC-GI/452a	Spare blade

Scalpel Handle

127mm long



Code	Description
SC-PM/007	No 3
SC-PM/008	No 4
SC-PM/008a	No 4 L
SC-PM/001a	No 7





Kidney Dish

Stainless steel

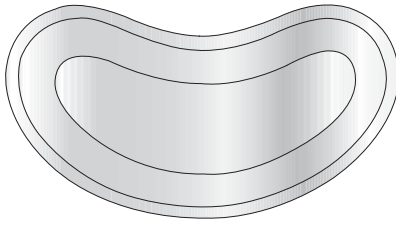

Code	Description
SC-GI/380	152mm
SC-GI/381	203mm
SC-GI/382	254mm
SC-GI/383	305mm

Cheatele Jar

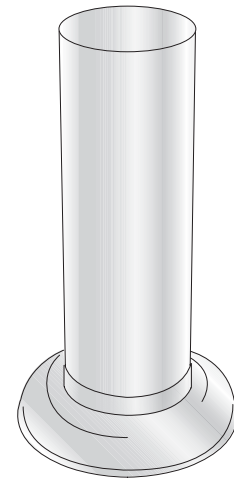

Code	Description
SC-GI/397	Stainless steel, 203mm x 50mm

Lotion Bowl

Without lid, stainless steel

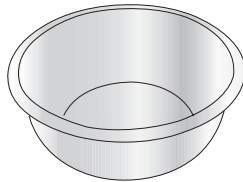

Code	Description
SC-GI/384	102mm
SC-GI/385	152mm
SC-GI/386	203mm
SC-GI/387	254mm
SC-GI/388	305mm

Measuring Jug



Code	Description
SC-GI/395	1 litre capacity

Instrument Tray

Stainless steel

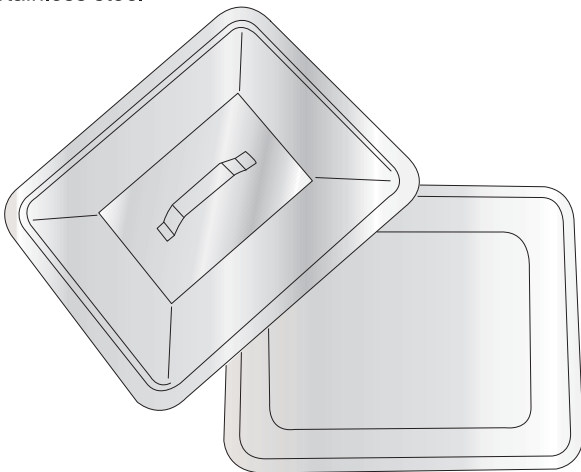

Code	Description
SC-GI/389	254 x 203 x 50mm
SC-GI/390	Lid only for 254 x 203 x 50mm
SC-GI/391	305 x 254 x 50mm
SC-GI/392	Lid only for 305 x 254 x 50mm
SC-GI/393	356 x 305 x 50mm
SC-GI/394	Lid only for 356 x 305 x 50mm

Petri Dish



Code	Description
SC-SH/002149	100mm, stainless steel, with lid

Gallipot

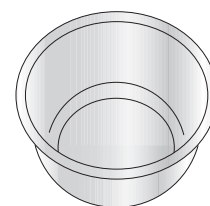

Code	Description
SC-GI/396	Stainless steel, 63mm

Silicone Matting & Sterilising Baskets

Silicone Matting

SILICONE MATTING AVAILABLE FOR ALL BASKETS - PLEASE ASK FOR PRICE

Medical grade for storage, sterilisation and transportation of instruments.

Cushion, protect, and organise delicate surgical instruments during storage, transportation, and sterilisation. Perforations allow for ventilation during the sterilisation process. The silicone mat can be cut to fit any size container.

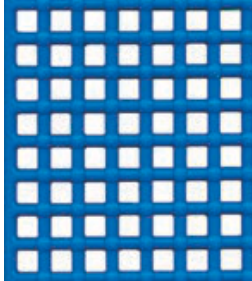

502mm long x 242mm wide
7mm holes, 10mm between holes

Code
BES/1004M

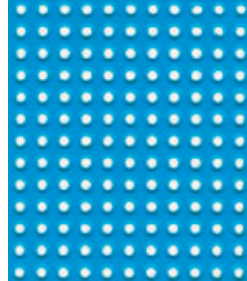

515mm long x 240mm wide
3mm holes, 6mm between holes

Code
BES/1001M

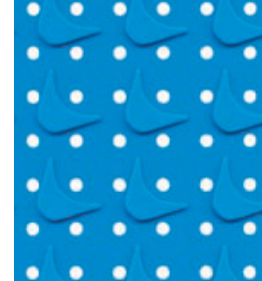

570mm long x 550mm wide
4mm holes, 13mm between holes

Code
BES/1002M

Sterilising Baskets

DIN Basket

Wire mesh base with perforated sides and two carrying handles

Code	Description
SC-GI/CO006	230 x 130 x 60mm
SC-GI/CO007	240 x 130 x 50mm
SC-GI/CO008	240 x 130 x 60mm
SC-GI/CO009	240 x 250 x 50mm
SC-GI/CO010	240 x 250 x 60mm
SC-GI/CO014	300 x 300 x 50mm
SC-GI/CO015	350 x 350 x 60mm
SC-GI/CO011	480 x 250 x 50mm
SC-GI/CO012	480 x 250 x 60mm

Code	Description
SC-GI/CO013	480 x 250 x 70mm
SC-GI/CO016	480 x 400 x 60mm
SC-GI/CO017	480 x 480 x 50mm
SC-GI/CO018	480 x 480 x 60mm
SC-GI/CO019	500 x 300 x 50mm
SC-GI/CO020	550 x 430 x 50mm
SC-GI/CO021	600 x 300 x 60mm



DIN Basket

Wire mesh basket with two carrying handles

Code	Description
SC-GI/CO022	240 x 250 x 50mm
SC-GI/CO023	240 x 250 x 60mm
SC-GI/CO024	240 x 250 x 70mm
SC-GI/CO031	300 x 300 x 60mm
SC-GI/CO025	480 x 250 x 50mm

Code	Description
SC-GI/CO026	480 x 250 x 60mm
SC-GI/CO027	480 x 250 x 70mm
SC-GI/CO028	480 x 250 x 100mm
SC-GI/CO029	480 x 480 x 50mm
SC-GI/CO030	480 x 480 x 70mm

DIN Basket Lids

For perforated and wire mesh baskets

Code	Description
SC-GI/CO032	240 x 250mm
SC-GI/CO033	300 x 300mm
SC-GI/CO034	480 x 250mm
SC-GI/CO035	480 x 480mm

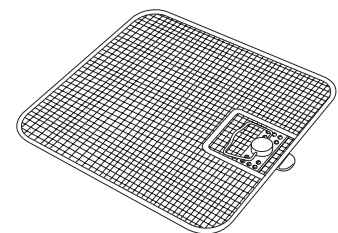



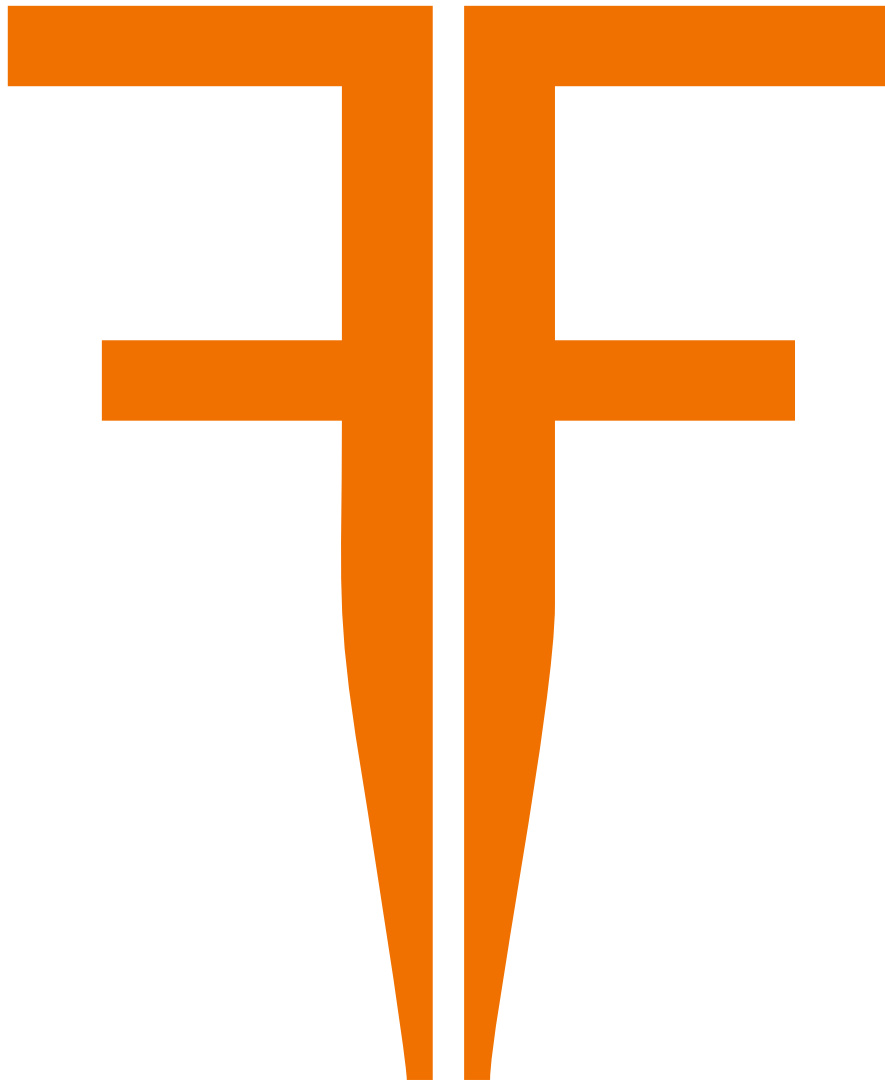

Forgefield International
Ugoki Road, Sialkot, Pakistan - 51311
E. info@forgefieldinternational.com
T. +92 302 912 9933
www.forgefieldinternational.com

